



# ល្បែងគូសតាមស្នាមចុច(ស្រះ (១១) និង ផាត់ពណ័រូបភាព



ស្កេន QR Code

សាលាមត្តេយ្យ ..... ថ្នាក់កម្រិត .....

ឈ្មោះ: ..... កាលបរិច្ឆេទ .....

កា

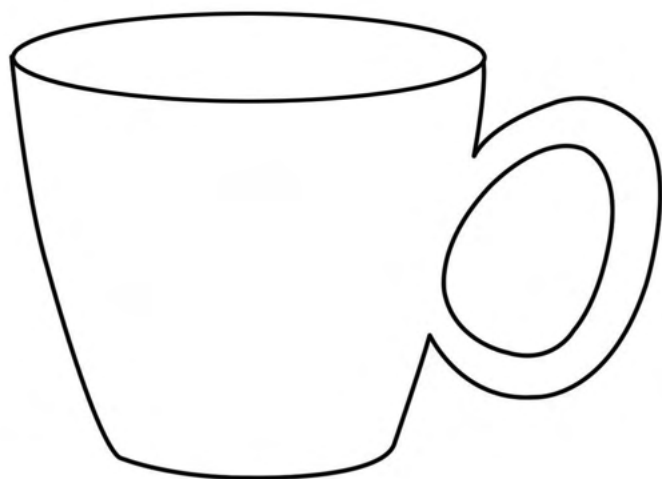

# ស្ថាវ (ស្រៈ: (០១) និងដាត់៣ណី



ស្កេន QR Code

សាលាមត្តេយ្យ ..... ថ្នាក់កម្រិត .....

ឈ្មោះ: ..... កាលបរិច្ឆេទ .....

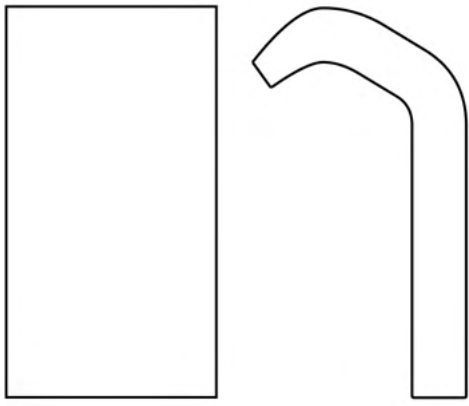
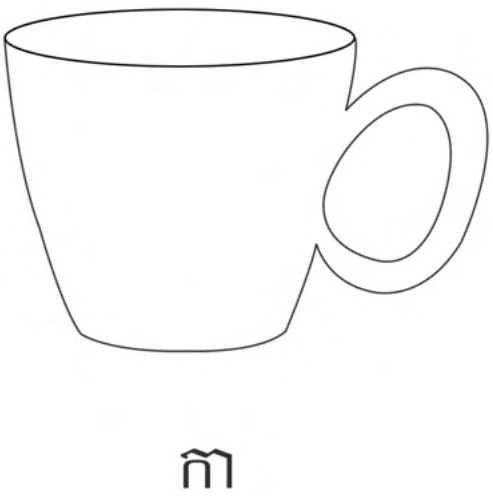
<p>១ .ដាត់៣ណីស្រៈ: (០១)</p>	<p>២ .គូររង្វង់ស្រៈ: (០១) និងដាត់៣ណីរូបភាព</p>																																											
		<table border="1"> <tr> <td data-bbox="1385 454 1428 694"></td> <td data-bbox="1428 454 1551 694">ក</td> </tr> <tr> <td data-bbox="1385 694 1428 940"></td> <td data-bbox="1428 694 1551 940">ា</td> </tr> <tr> <td data-bbox="1385 940 1428 1182"></td> <td data-bbox="1428 940 1551 1182">កា</td> </tr> </table>		ក		ា		កា																																				
	ក																																											
	ា																																											
	កា																																											
<p>៣ .គូសតាមស្នាមចុចស្រៈ: (០១)</p>	<p>៤ .គូររង្វង់ជុំវិញស្រៈ: (០១)</p>																																											
<table border="1"> <tr> <td data-bbox="87 1344 167 1489">ក</td> <td data-bbox="175 1344 263 1489">ា</td> <td data-bbox="335 1344 414 1489">ក</td> <td data-bbox="422 1344 502 1489">ា</td> <td data-bbox="582 1344 662 1489">ក</td> <td data-bbox="670 1344 750 1489">ា</td> </tr> <tr> <td data-bbox="87 1568 167 1713">ក</td> <td data-bbox="175 1568 263 1713">ា</td> <td data-bbox="335 1568 414 1713">ក</td> <td data-bbox="422 1568 502 1713">ា</td> <td data-bbox="582 1568 662 1713">ក</td> <td data-bbox="670 1568 750 1713">ា</td> </tr> <tr> <td data-bbox="87 1803 167 1948">ក</td> <td data-bbox="175 1803 263 1948">ា</td> <td data-bbox="335 1803 414 1948">ក</td> <td data-bbox="422 1803 502 1948">ា</td> <td data-bbox="582 1803 662 1948">ក</td> <td data-bbox="670 1803 750 1948">ា</td> </tr> </table>	ក	ា	ក	ា	ក	ា	ក	ា	ក	ា	ក	ា	ក	ា	ក	ា	ក	ា	<table border="1"> <tr> <td data-bbox="837 1344 917 1433">ក</td> <td data-bbox="989 1321 1037 1433">ា</td> <td data-bbox="1141 1321 1189 1433">ក</td> <td data-bbox="1292 1355 1340 1433">ា</td> <td data-bbox="1444 1355 1492 1433">ក</td> <td data-bbox="1484 1355 1532 1433">ា</td> </tr> <tr> <td data-bbox="837 1478 885 1590">ក</td> <td data-bbox="989 1512 1037 1590">ា</td> <td data-bbox="1141 1478 1189 1590">ក</td> <td data-bbox="1292 1512 1340 1590">ា</td> <td data-bbox="1444 1512 1492 1590">ក</td> <td data-bbox="1484 1512 1532 1590">ា</td> </tr> <tr> <td data-bbox="837 1635 885 1747">ក</td> <td data-bbox="989 1668 1037 1747">ា</td> <td data-bbox="1141 1635 1189 1747">ក</td> <td data-bbox="1292 1668 1340 1747">ា</td> <td data-bbox="1444 1668 1492 1747">ក</td> <td data-bbox="1484 1668 1532 1747">ា</td> </tr> <tr> <td data-bbox="837 1848 917 1937">ក</td> <td data-bbox="989 1848 1037 1937">ា</td> <td data-bbox="1141 1825 1189 1937">ក</td> <td data-bbox="1292 1848 1340 1937">ា</td> <td data-bbox="1444 1848 1492 1937">ក</td> <td data-bbox="1484 1848 1532 1937">ា</td> </tr> </table>		ក	ា	ក	ា	ក	ា	ក	ា	ក	ា	ក	ា	ក	ា	ក	ា	ក	ា	ក	ា	ក	ា	ក	ា
ក	ា	ក	ា	ក	ា																																							
ក	ា	ក	ា	ក	ា																																							
ក	ា	ក	ា	ក	ា																																							
ក	ា	ក	ា	ក	ា																																							
ក	ា	ក	ា	ក	ា																																							
ក	ា	ក	ា	ក	ា																																							
ក	ា	ក	ា	ក	ា																																							













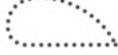

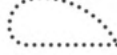

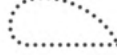

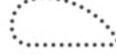
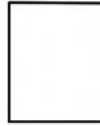
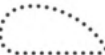
ល្បែងគូសតាមស្នាមចុច(ស្រះ (ៀ) និង ផាត់ពណ៌រូបភាព

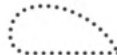

ស្កេន QR Code

សាលាមត្តេយ្យ ..... ថ្នាក់កម្រិត .....

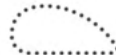
ឈ្មោះ: ..... កាលបរិច្ឆេទ .....

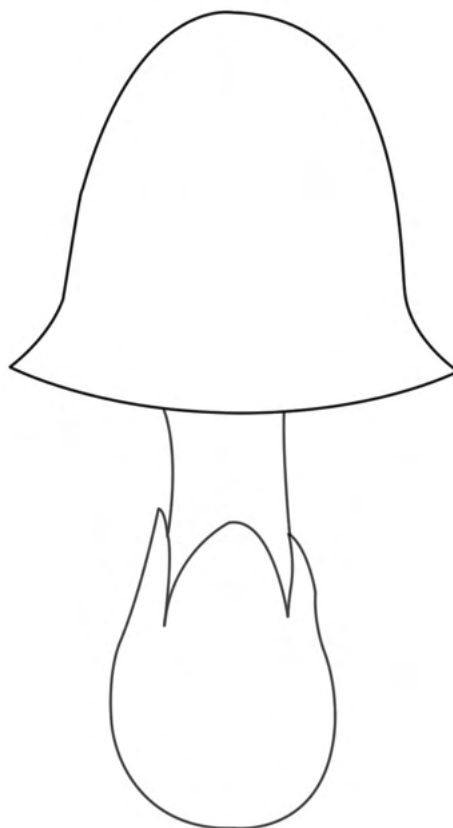

ផ្សិត













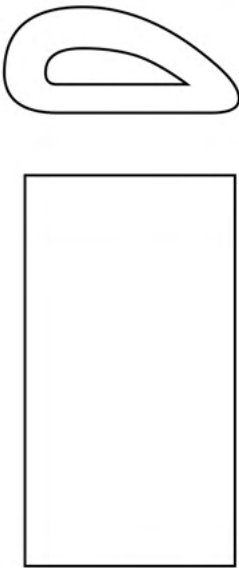
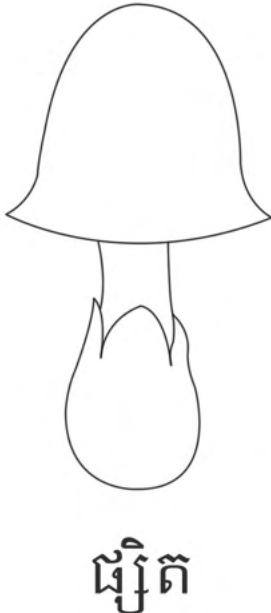

































































































































































# ស្នាស់ (ស្រះ) (ពី) និង ដាត់ពណ៌



ស្កេន QR Code

សាលាមត្តេយ្យ ..... ថ្នាក់កម្រិត .....

ឈ្មោះ: ..... កាលបរិច្ឆេទ .....

<p>១ .ដាត់ពណ៌ស្រះ: (ពី)</p>	<p>២ .គូររង្វង់ស្រះ: (ពី) និងដាត់ពណ៌រូបភាព</p>																																																							
	 <p>ជ្រូត</p>	<table border="1"> <tr> <td data-bbox="1383 452 1546 696">  </td> </tr> <tr> <td data-bbox="1383 696 1546 940">  </td> </tr> <tr> <td data-bbox="1383 940 1546 1182">  </td> </tr> </table>																																																						
																																																								
																																																								
																																																								
<p>៣ .គូសតាមស្នាមចុចស្រះ: (ពី)</p>	<p>៤ .គូររង្វង់ជុំវិញស្រះ: (ពី)</p>																																																							
<table border="1"> <tr> <td></td> <td></td> <td></td> <td></td> </tr> <tr> <td></td> <td></td> <td></td> <td></td> </tr> <tr> <td></td> <td></td> <td></td> <td></td> </tr> <tr> <td></td> <td></td> <td></td> <td></td> </tr> <tr> <td></td> <td></td> <td></td> <td></td> </tr> <tr> <td></td> <td></td> <td></td> <td></td> </tr> </table>																									<table border="1"> <tr> <td></td> <td></td> <td></td> <td></td> <td></td> </tr> <tr> <td></td> <td></td> <td></td> <td></td> <td></td> </tr> <tr> <td></td> <td></td> <td></td> <td></td> <td></td> </tr> <tr> <td></td> <td></td> <td></td> <td></td> <td></td> </tr> <tr> <td></td> <td></td> <td></td> <td></td> <td></td> </tr> <tr> <td></td> <td></td> <td></td> <td></td> <td></td> </tr> </table>																															
																																																								
																																																								
																																																								
																																																								
																																																								
																																																								
																																																								
																																																								
																																																								
																																																								
																																																								
																																																								

# ល្បែងគូសតាមស្នាមចុច(ស្រ: (០)) និង ដាត់ពណ័រូបភាព



ស្កែន QR Code

សាលាមត្តេយ្យ ..... ថ្នាក់កម្រិត .....

ឈ្មោះ: ..... កាលបរិច្ឆេទ .....



ស



# ស្ថា ល់ (្រៈ) និង ផាត់ ពណី



ស្កេន QR Code

សាលាមត្តេយ្យ ..... ថ្នាក់កម្រិត .....

ឈ្មោះ ..... កាលបរិច្ឆេទ .....

<p>១ . ផាត់ ពណី ស្រៈ : ( ី )</p> <div style="text-align: center;"> </div>	<p>២ . គូរ រង្វង់ ស្រៈ : ( ី ) និង ផាត់ ពណី រូបភាព</p> <div style="text-align: center;"> </div> <div style="display: flex; justify-content: space-around; align-items: center;"> <div style="text-align: center;"> <p>ឺ</p> <input type="checkbox"/> </div> <div style="text-align: center;"> <p>ឺ</p> <input type="checkbox"/> </div> <div style="text-align: center;"> <p>ឺ</p> <input type="checkbox"/> </div> </div>
<p>៣ . គូស តាម ស្នាម ចុច ស្រៈ : ( ី )</p> <div style="display: flex; justify-content: space-between;"> <div style="text-align: center;"> <p>ឺ</p> <input type="checkbox"/> </div> <div style="text-align: center;"> <p>ឺ</p> <input type="checkbox"/> </div> <div style="text-align: center;"> <p>ឺ</p> <input type="checkbox"/> </div> <div style="text-align: center;"> <p>ឺ</p> <input type="checkbox"/> </div> </div> <div style="display: flex; justify-content: space-between;"> <div style="text-align: center;"> <p>ឺ</p> <input type="checkbox"/> </div> <div style="text-align: center;"> <p>ឺ</p> <input type="checkbox"/> </div> <div style="text-align: center;"> <p>ឺ</p> <input type="checkbox"/> </div> <div style="text-align: center;"> <p>ឺ</p> <input type="checkbox"/> </div> </div> <div style="display: flex; justify-content: space-between;"> <div style="text-align: center;"> <p>ឺ</p> <input type="checkbox"/> </div> <div style="text-align: center;"> <p>ឺ</p> <input type="checkbox"/> </div> <div style="text-align: center;"> <p>ឺ</p> <input type="checkbox"/> </div> <div style="text-align: center;"> <p>ឺ</p> <input type="checkbox"/> </div> </div>	<p>៤ . គូរ រង្វង់ ជុំវិញ ស្រៈ : ( ី )</p> <div style="display: flex; justify-content: space-between;"> <div style="text-align: center;"> <p>ឺ</p> <input type="checkbox"/> </div> <div style="text-align: center;"> <p>ឺ</p> <input type="checkbox"/> </div> <div style="text-align: center;"> <p>ឺ</p> <input type="checkbox"/> </div> <div style="text-align: center;"> <p>ឺ</p> <input type="checkbox"/> </div> </div> <div style="display: flex; justify-content: space-between;"> <div style="text-align: center;"> <p>ឺ</p> <input type="checkbox"/> </div> <div style="text-align: center;"> <p>ឺ</p> <input type="checkbox"/> </div> <div style="text-align: center;"> <p>ឺ</p> <input type="checkbox"/> </div> <div style="text-align: center;"> <p>ឺ</p> <input type="checkbox"/> </div> </div> <div style="display: flex; justify-content: space-between;"> <div style="text-align: center;"> <p>ឺ</p> <input type="checkbox"/> </div> <div style="text-align: center;"> <p>ឺ</p> <input type="checkbox"/> </div> <div style="text-align: center;"> <p>ឺ</p> <input type="checkbox"/> </div> <div style="text-align: center;"> <p>ឺ</p> <input type="checkbox"/> </div> </div> <div style="display: flex; justify-content: space-between;"> <div style="text-align: center;"> <p>ឺ</p> <input type="checkbox"/> </div> <div style="text-align: center;"> <p>ឺ</p> <input type="checkbox"/> </div> <div style="text-align: center;"> <p>ឺ</p> <input type="checkbox"/> </div> <div style="text-align: center;"> <p>ឺ</p> <input type="checkbox"/> </div> </div>

ល្បែងគូសតាមស្នាមចុច(ស្រ: (ី) និង  
 ផាត់ពណ័រូបភាព



ស្កេន QR Code

សាលាមត្តេយ្យ ..... ផ្នែកកម្រិត .....

ឈ្មោះ: ..... កាលបរិច្ឆេទ .....



ឱ ក













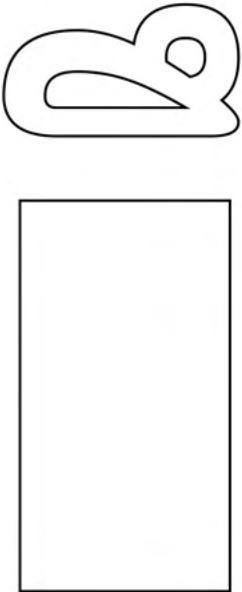



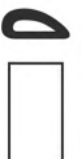

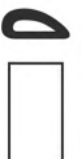

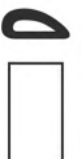
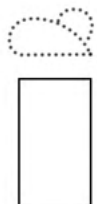
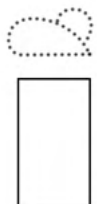
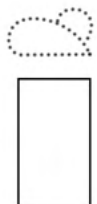
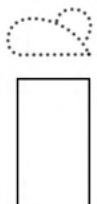

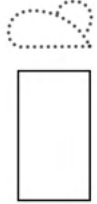

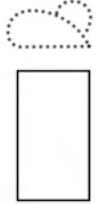
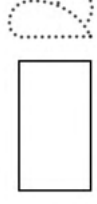
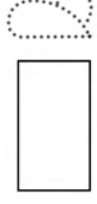
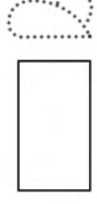
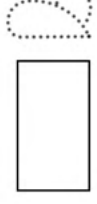
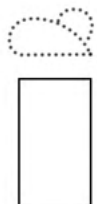
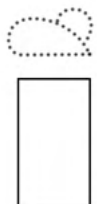
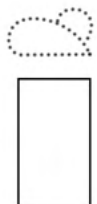
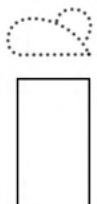

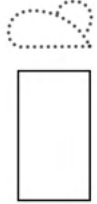

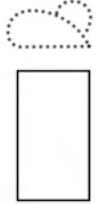
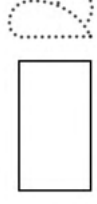
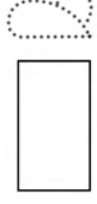
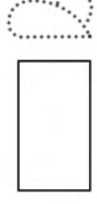
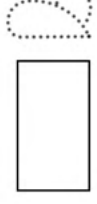
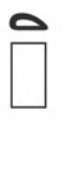
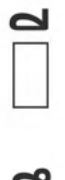







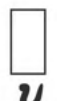





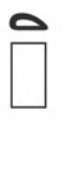
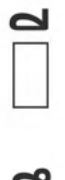







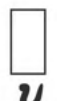





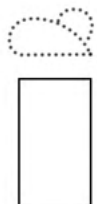
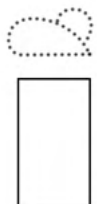
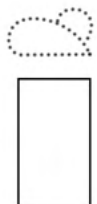
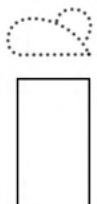

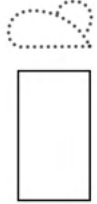

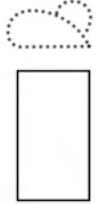
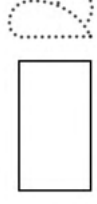
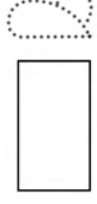
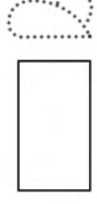
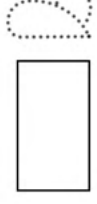
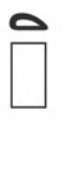
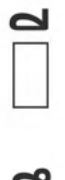



# ស្នាស់(ស្រះ: (បី) និងដាត់ពណ៌

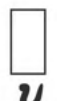

ស្កេន QR Code

សាលាមត្តេយ្យ ..... ថ្នាក់កម្រិត .....

ឈ្មោះ: ..... កាលបរិច្ឆេទ .....

<p>១ .ដាត់ពណ៌ស្រះ: (បី)</p>	<p>២ .គូររង្វង់ស្រះ: (បី) និងដាត់ពណ៌រូបភាព</p>																											
	 <p>ធីតា</p>	<table border="1"> <tr> <td data-bbox="1385 454 1551 694">  </td> </tr> <tr> <td data-bbox="1385 694 1551 940">  </td> </tr> <tr> <td data-bbox="1385 940 1551 1182">  </td> </tr> </table>																										
																												
																												
																												
<p>៣ .គូសតាមស្នាមចុចស្រះ: (បី)</p>	<p>៤ .គូររង្វង់ជុំវិញស្រះ: (បី)</p>																											
<table border="1"> <tr> <td data-bbox="51 1288 183 1523">  </td> <td data-bbox="183 1288 316 1523">  </td> <td data-bbox="316 1288 448 1523">  </td> <td data-bbox="448 1288 794 1523">  </td> </tr> <tr> <td data-bbox="51 1523 183 1758">  </td> <td data-bbox="183 1523 316 1758">  </td> <td data-bbox="316 1523 448 1758">  </td> <td data-bbox="448 1523 794 1758">  </td> </tr> <tr> <td data-bbox="51 1758 183 2000">  </td> <td data-bbox="183 1758 316 2000">  </td> <td data-bbox="316 1758 448 2000">  </td> <td data-bbox="448 1758 794 2000">  </td> </tr> </table>													<table border="1"> <tr> <td data-bbox="794 1288 927 1523">  </td> <td data-bbox="927 1288 1059 1523">  </td> <td data-bbox="1059 1288 1192 1523">  </td> <td data-bbox="1192 1288 1324 1523">  </td> <td data-bbox="1324 1288 1457 1523">  </td> </tr> <tr> <td data-bbox="794 1523 927 1758">  </td> <td data-bbox="927 1523 1059 1758">  </td> <td data-bbox="1059 1523 1192 1758">  </td> <td data-bbox="1192 1523 1324 1758">  </td> <td data-bbox="1324 1523 1457 1758">  </td> </tr> <tr> <td data-bbox="794 1758 927 2000">  </td> <td data-bbox="927 1758 1059 2000">  </td> <td data-bbox="1059 1758 1192 2000">  </td> <td data-bbox="1192 1758 1324 2000">  </td> <td data-bbox="1324 1758 1457 2000">  </td> </tr> </table>															
																												
																												
																												
																												
																												
																												

# ល្បែងគូសភ្ជាប់ (ស្រះទៅនឹងរូបភាព និងផ្ទាំងពណ៌)



ស្កេន QR Code

សាលាមត្តេយ្យ ..... ថ្នាក់កម្រិត .....

ឈ្មោះ : ..... កាលបរិច្ឆេទ .....

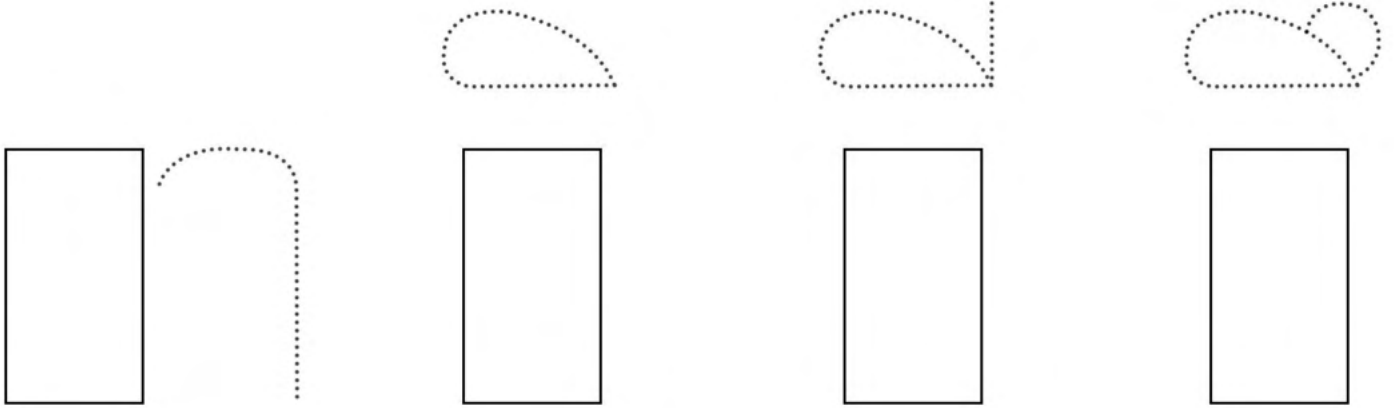

ផ្ទឹក



ស៊ី



ផ្សិត



កែវ

# ល្បែងគូសភ្នាបំភាន់ម្តាយ

សាលាមត្តេយ្យ .....

ថ្នាក់កម្រិត .....

ឈ្មោះ : .....

កាលបរិច្ឆេទ .....



ស្ត្រីន QR Code

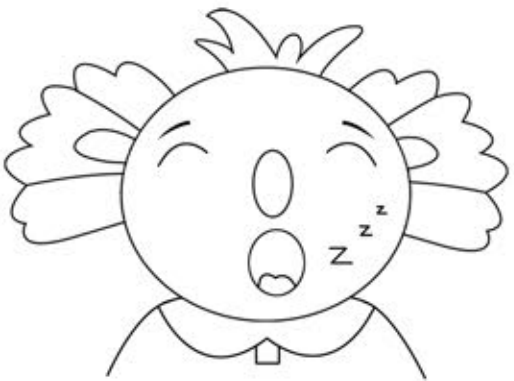
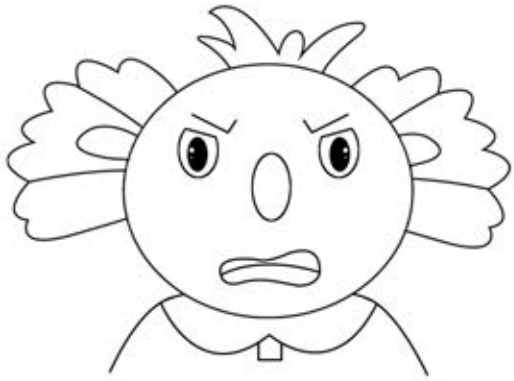
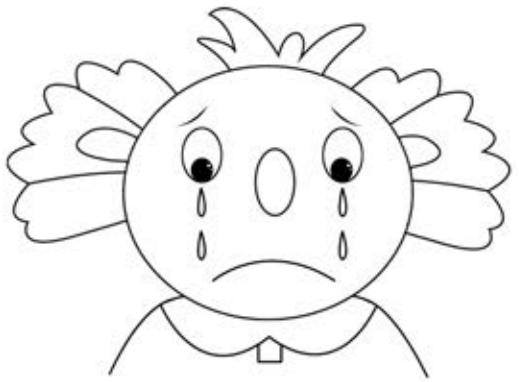
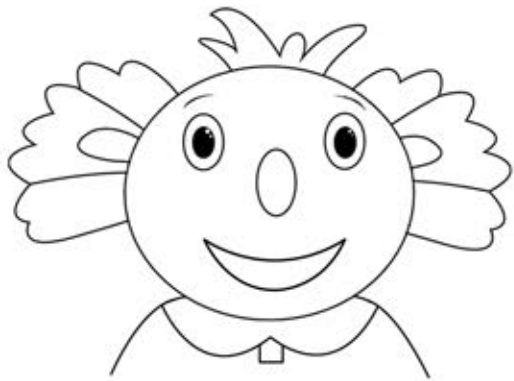

ល្បែងគូសតាមស្នាមចុច(ស្រះ (្ក) និង ផាត់ពណ៌រូបភាព



ស្កេន QR Code

សាលាមត្តេយ្យ ..... ថ្នាក់កម្រិត .....

ឈ្មោះ: ..... កាលបរិច្ឆេទ .....

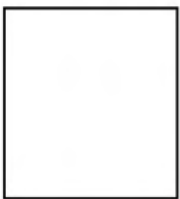
ឃ



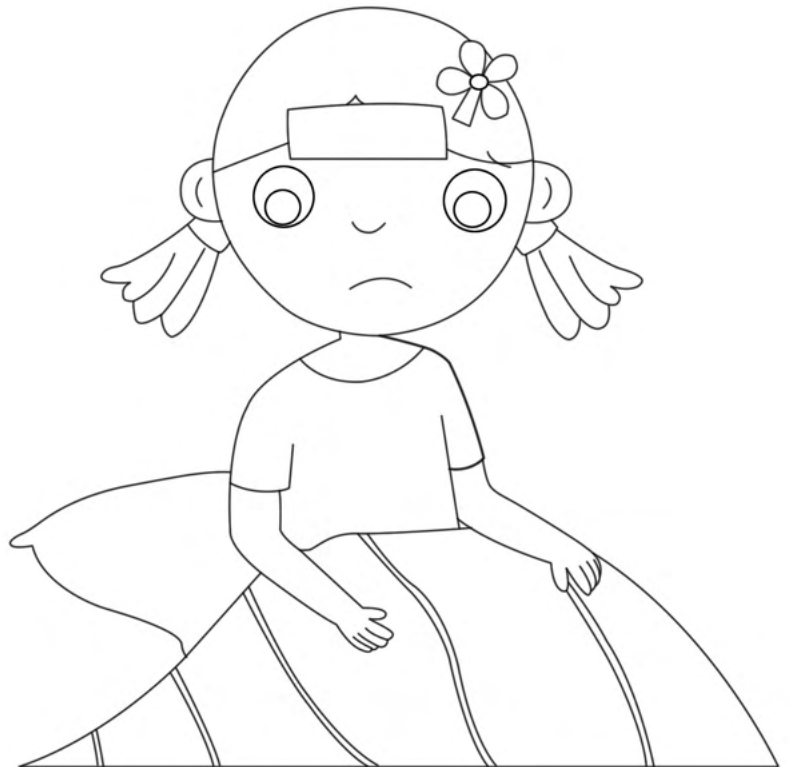



# ស្នាស់ស្រែ (ឺ) និងផាត់ពណ៌



ស្កេន QR Code

សាលាមត្តេយ្យ ..... ថ្នាក់កម្រិត .....

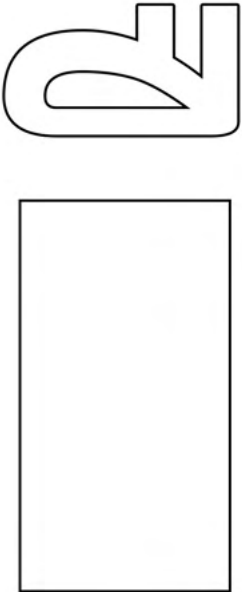
ឈ្មោះ ..... កាលបរិច្ឆេទ .....

<p>១ .ផាត់ពណ៌ស្រែ: (ឺ)</p>	<p>២ .គូររង្វង់ស្រែ: (ឺ) និងផាត់ពណ៌រូបភាព</p>																																																	
	 <p style="text-align: center;">ឈឺ</p>	<table border="1" style="width: 100%; height: 100%;"> <tr> <td style="text-align: center;">ឺ</td> <td style="width: 40px; height: 40px;"></td> </tr> <tr> <td style="text-align: center;">ឺ</td> <td style="width: 40px; height: 40px;"></td> </tr> <tr> <td style="text-align: center;">ឺ</td> <td style="width: 40px; height: 40px;"></td> </tr> </table>	ឺ		ឺ		ឺ																																											
ឺ																																																		
ឺ																																																		
ឺ																																																		
<p>៣ .គូសតាមស្នាមចុចស្រែ: (ឺ)</p>	<p>៤ .គូររង្វង់ជុំវិញស្រែ: (ឺ)</p>																																																	
<table style="width: 100%; text-align: center;"> <tr> <td>ឺ</td><td>ឺ</td><td>ឺ</td><td>ឺ</td></tr> <tr> <td style="width: 40px; height: 40px;"></td><td style="width: 40px; height: 40px;"></td><td style="width: 40px; height: 40px;"></td><td style="width: 40px; height: 40px;"></td></tr> <tr> <td>ឺ</td><td>ឺ</td><td>ឺ</td><td>ឺ</td></tr> <tr> <td style="width: 40px; height: 40px;"></td><td style="width: 40px; height: 40px;"></td><td style="width: 40px; height: 40px;"></td><td style="width: 40px; height: 40px;"></td></tr> <tr> <td>ឺ</td><td>ឺ</td><td>ឺ</td><td>ឺ</td></tr> <tr> <td style="width: 40px; height: 40px;"></td><td style="width: 40px; height: 40px;"></td><td style="width: 40px; height: 40px;"></td><td style="width: 40px; height: 40px;"></td></tr> </table>	ឺ	ឺ	ឺ	ឺ					ឺ	ឺ	ឺ	ឺ					ឺ	ឺ	ឺ	ឺ					<table style="width: 100%; text-align: center;"> <tr> <td>ឺ</td><td>ឺ</td><td>ឺ</td><td>ឺ</td></tr> <tr> <td style="width: 40px; height: 40px;"></td><td style="width: 40px; height: 40px;"></td><td style="width: 40px; height: 40px;"></td><td style="width: 40px; height: 40px;"></td></tr> <tr> <td>ឺ</td><td>ឺ</td><td>ឺ</td><td>ឺ</td></tr> <tr> <td style="width: 40px; height: 40px;"></td><td style="width: 40px; height: 40px;"></td><td style="width: 40px; height: 40px;"></td><td style="width: 40px; height: 40px;"></td></tr> <tr> <td>ឺ</td><td>ឺ</td><td>ឺ</td><td>ឺ</td></tr> <tr> <td style="width: 40px; height: 40px;"></td><td style="width: 40px; height: 40px;"></td><td style="width: 40px; height: 40px;"></td><td style="width: 40px; height: 40px;"></td></tr> </table>		ឺ	ឺ	ឺ	ឺ					ឺ	ឺ	ឺ	ឺ					ឺ	ឺ	ឺ	ឺ				
ឺ	ឺ	ឺ	ឺ																																															
ឺ	ឺ	ឺ	ឺ																																															
ឺ	ឺ	ឺ	ឺ																																															
ឺ	ឺ	ឺ	ឺ																																															
ឺ	ឺ	ឺ	ឺ																																															
ឺ	ឺ	ឺ	ឺ																																															

# ល្បែងគូសតាមស្នាមចុច(ស្រះ (្ក)និង ផាត់ពណ័រូបភាព



ស្ត្រេន QR Code

សាលាមត្តេយ្យ ..... ផ្នែកកម្រិត .....

ឈ្មោះ: ..... កាលបរិច្ឆេទ .....



ត្រង់

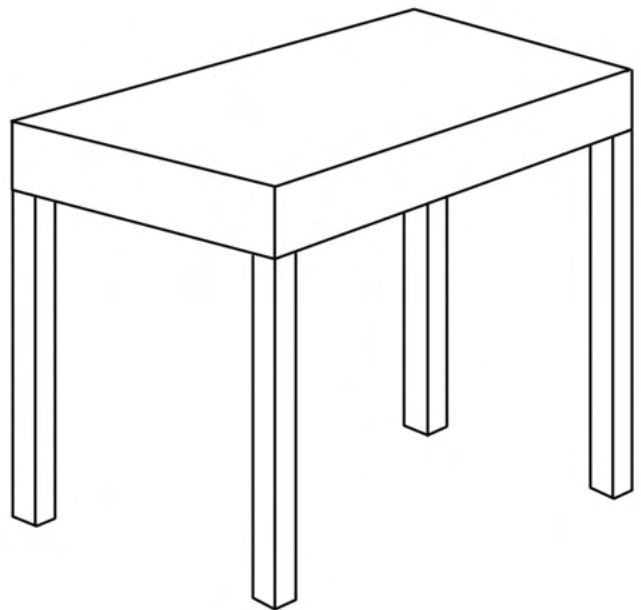

# ស្ទាស់ស្រែ (០) និងដាត់ពណ៌



ស្កេន QR Code

សាលាមត្តេយ្យ ..... ថ្នាក់កម្រិត .....

ឈ្មោះ ..... កាលបរិច្ឆេទ .....

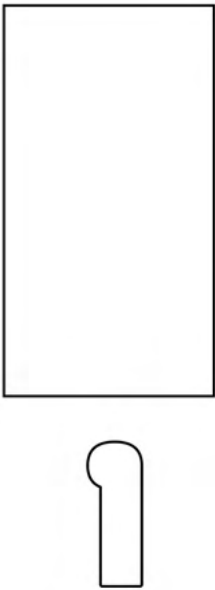
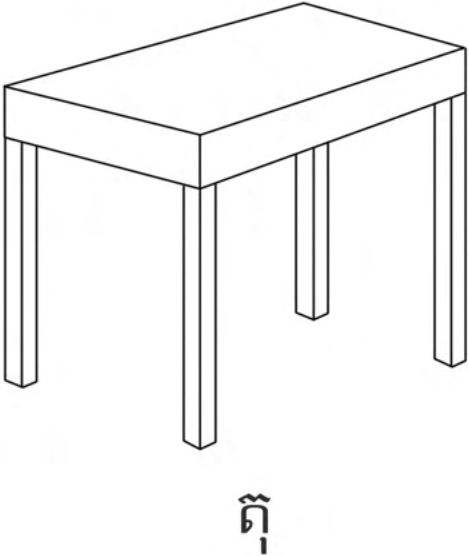
<p>១ .ដាត់ពណ៌ស្រែ: (០)</p>	<p>២ .គូររង្វង់ស្រែ: (០) និងដាត់ពណ៌រូបភាព</p>																																																												
		<table border="1"> <tr> <td data-bbox="1383 452 1546 696"> <p>៣</p> <input type="checkbox"/> </td> </tr> <tr> <td data-bbox="1383 696 1546 940"> <p>៤</p> <input type="checkbox"/> </td> </tr> <tr> <td data-bbox="1383 940 1546 1182"> <p>៥</p> <input type="checkbox"/> </td> </tr> </table>	<p>៣</p> <input type="checkbox"/>	<p>៤</p> <input type="checkbox"/>	<p>៥</p> <input type="checkbox"/>																																																								
<p>៣</p> <input type="checkbox"/>																																																													
<p>៤</p> <input type="checkbox"/>																																																													
<p>៥</p> <input type="checkbox"/>																																																													
<p>៣ .គូសតាមស្នាមចុចស្រែ: (០)</p>	<p>៤ .គូររង្វង់ជុំវិញស្រែ: (០)</p>																																																												
<table border="1"> <tr> <td><input type="checkbox"/></td> <td><input type="checkbox"/></td> <td><input type="checkbox"/></td> <td><input type="checkbox"/></td> </tr> <tr> <td></td> <td></td> <td></td> <td></td> </tr> <tr> <td><input type="checkbox"/></td> <td><input type="checkbox"/></td> <td><input type="checkbox"/></td> <td><input type="checkbox"/></td> </tr> <tr> <td></td> <td></td> <td></td> <td></td> </tr> <tr> <td><input type="checkbox"/></td> <td><input type="checkbox"/></td> <td><input type="checkbox"/></td> <td><input type="checkbox"/></td> </tr> <tr> <td></td> <td></td> <td></td> <td></td> </tr> </table>	<input type="checkbox"/>	<input type="checkbox"/>	<input type="checkbox"/>	<input type="checkbox"/>					<input type="checkbox"/>	<input type="checkbox"/>	<input type="checkbox"/>	<input type="checkbox"/>					<input type="checkbox"/>	<input type="checkbox"/>	<input type="checkbox"/>	<input type="checkbox"/>					<table border="1"> <tr> <td><input type="checkbox"/></td> <td><input type="checkbox"/></td> <td><input type="checkbox"/></td> <td><input type="checkbox"/></td> <td><input type="checkbox"/></td> </tr> <tr> <td>៦</td> <td>៧</td> <td>៨</td> <td>៩</td> <td>១០</td> </tr> <tr> <td><input type="checkbox"/></td> <td><input type="checkbox"/></td> <td><input type="checkbox"/></td> <td><input type="checkbox"/></td> <td><input type="checkbox"/></td> </tr> <tr> <td>១១</td> <td>១២</td> <td>១៣</td> <td>១៤</td> <td>១៥</td> </tr> <tr> <td><input type="checkbox"/></td> <td><input type="checkbox"/></td> <td><input type="checkbox"/></td> <td><input type="checkbox"/></td> <td><input type="checkbox"/></td> </tr> <tr> <td>១៦</td> <td>១៧</td> <td>១៨</td> <td>១៩</td> <td>២០</td> </tr> <tr> <td><input type="checkbox"/></td> <td><input type="checkbox"/></td> <td><input type="checkbox"/></td> <td><input type="checkbox"/></td> <td><input type="checkbox"/></td> </tr> </table>		<input type="checkbox"/>	<input type="checkbox"/>	<input type="checkbox"/>	<input type="checkbox"/>	<input type="checkbox"/>	៦	៧	៨	៩	១០	<input type="checkbox"/>	<input type="checkbox"/>	<input type="checkbox"/>	<input type="checkbox"/>	<input type="checkbox"/>	១១	១២	១៣	១៤	១៥	<input type="checkbox"/>	<input type="checkbox"/>	<input type="checkbox"/>	<input type="checkbox"/>	<input type="checkbox"/>	១៦	១៧	១៨	១៩	២០	<input type="checkbox"/>	<input type="checkbox"/>	<input type="checkbox"/>	<input type="checkbox"/>	<input type="checkbox"/>
<input type="checkbox"/>	<input type="checkbox"/>	<input type="checkbox"/>	<input type="checkbox"/>																																																										
<input type="checkbox"/>	<input type="checkbox"/>	<input type="checkbox"/>	<input type="checkbox"/>																																																										
<input type="checkbox"/>	<input type="checkbox"/>	<input type="checkbox"/>	<input type="checkbox"/>																																																										
<input type="checkbox"/>	<input type="checkbox"/>	<input type="checkbox"/>	<input type="checkbox"/>	<input type="checkbox"/>																																																									
៦	៧	៨	៩	១០																																																									
<input type="checkbox"/>	<input type="checkbox"/>	<input type="checkbox"/>	<input type="checkbox"/>	<input type="checkbox"/>																																																									
១១	១២	១៣	១៤	១៥																																																									
<input type="checkbox"/>	<input type="checkbox"/>	<input type="checkbox"/>	<input type="checkbox"/>	<input type="checkbox"/>																																																									
១៦	១៧	១៨	១៩	២០																																																									
<input type="checkbox"/>	<input type="checkbox"/>	<input type="checkbox"/>	<input type="checkbox"/>	<input type="checkbox"/>																																																									

ល្បែងគូសតាមស្នាមចុច(ស្រះ (□)និង  
 ផ្ទាំងពណ៌រូបភាព



ស្កេន QR Code

សាលាមត្តេយ្យ ..... ថ្នាក់កម្រិត .....

ឈ្មោះ: ..... កាលបរិច្ឆេទ .....

□ <b>ប</b>	□ ប	□ ប	□ ប	□ ប
□ ប	□ ប	□ ប	□ ប	□ ប



ប្រ

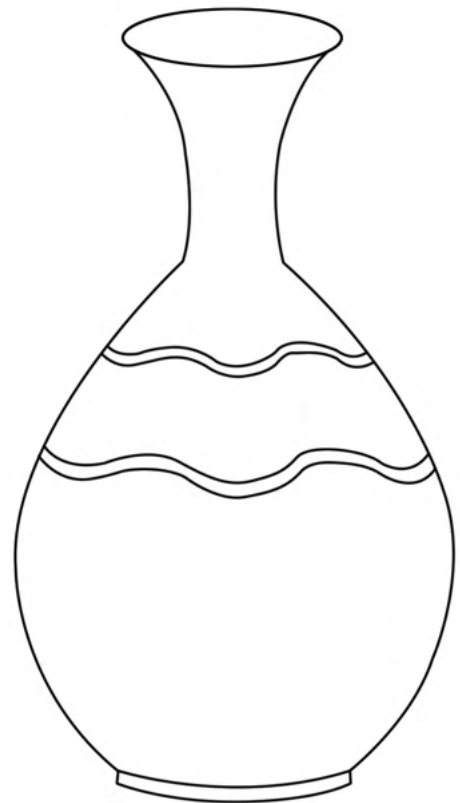













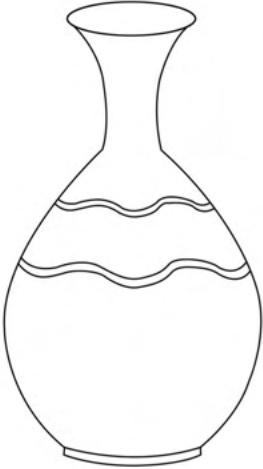













ស្ថាវ័រ (១) និង ផ្កាត័រ (១)



ស្កេន QR Code

សាលាមត្តេយ្យ ..... ថ្នាក់កម្រិត .....

ឈ្មោះ ..... កាលបរិច្ឆេទ .....

<p>១ . ផ្កាត័រ (១)</p> <div style="text-align: center;">    </div>	<p>២ . គូររង្វង់ (១) និង ផ្កាត័ររូបភាព</p> <div style="text-align: center;">    </div> <div style="float: right; width: 100px;"> <div style="border: 1px solid black; width: 40px; height: 40px; margin-bottom: 5px;"></div> <p style="text-align: center; margin: 0;">ឃ</p> <hr/> <div style="border: 1px solid black; width: 40px; height: 40px; margin-bottom: 5px;"></div> <p style="text-align: center; margin: 0;">១</p> <hr/> <div style="border: 1px solid black; width: 40px; height: 40px; margin-bottom: 5px;"></div> <p style="text-align: center; margin: 0;">ឃ</p> </div>
<p>៣ . គូសតាមស្នាមចុចស្រះ (១)</p> <div style="display: flex; justify-content: space-around;"> <div style="text-align: center;"> <div style="border: 1px solid black; width: 40px; height: 40px; margin-bottom: 5px;"></div>  </div> <div style="text-align: center;"> <div style="border: 1px solid black; width: 40px; height: 40px; margin-bottom: 5px;"></div>  </div> <div style="text-align: center;"> <div style="border: 1px solid black; width: 40px; height: 40px; margin-bottom: 5px;"></div>  </div> <div style="text-align: center;"> <div style="border: 1px solid black; width: 40px; height: 40px; margin-bottom: 5px;"></div>  </div> </div> <div style="display: flex; justify-content: space-around; margin-top: 20px;"> <div style="text-align: center;"> <div style="border: 1px solid black; width: 40px; height: 40px; margin-bottom: 5px;"></div>  </div> <div style="text-align: center;"> <div style="border: 1px solid black; width: 40px; height: 40px; margin-bottom: 5px;"></div>  </div> <div style="text-align: center;"> <div style="border: 1px solid black; width: 40px; height: 40px; margin-bottom: 5px;"></div>  </div> <div style="text-align: center;"> <div style="border: 1px solid black; width: 40px; height: 40px; margin-bottom: 5px;"></div>  </div> </div>	<p>៤ . គូររង្វង់ជុំវិញស្រះ (១)</p> <div style="display: flex; justify-content: space-around;"> <div style="text-align: center;"> <div style="border: 1px solid black; width: 40px; height: 40px; margin-bottom: 5px;"></div>  </div> <div style="text-align: center;"> <div style="border: 1px solid black; width: 40px; height: 40px; margin-bottom: 5px;"></div>  </div> <div style="text-align: center;"> <div style="border: 1px solid black; width: 40px; height: 40px; margin-bottom: 5px;"></div>  </div> <div style="text-align: center;"> <div style="border: 1px solid black; width: 40px; height: 40px; margin-bottom: 5px;"></div>  </div> <div style="text-align: center;"> <div style="border: 1px solid black; width: 40px; height: 40px; margin-bottom: 5px;"></div>  </div> </div> <div style="display: flex; justify-content: space-around; margin-top: 20px;"> <div style="text-align: center;"> <div style="border: 1px solid black; width: 40px; height: 40px; margin-bottom: 5px;"></div>  </div> <div style="text-align: center;"> <div style="border: 1px solid black; width: 40px; height: 40px; margin-bottom: 5px;"></div>  </div> <div style="text-align: center;"> <div style="border: 1px solid black; width: 40px; height: 40px; margin-bottom: 5px;"></div>  </div> <div style="text-align: center;"> <div style="border: 1px solid black; width: 40px; height: 40px; margin-bottom: 5px;"></div>  </div> <div style="text-align: center;"> <div style="border: 1px solid black; width: 40px; height: 40px; margin-bottom: 5px;"></div>  </div> </div> <div style="display: flex; justify-content: space-around; margin-top: 20px;"> <div style="text-align: center;"> <div style="border: 1px solid black; width: 40px; height: 40px; margin-bottom: 5px;"></div>  </div> <div style="text-align: center;"> <div style="border: 1px solid black; width: 40px; height: 40px; margin-bottom: 5px;"></div>  </div> <div style="text-align: center;"> <div style="border: 1px solid black; width: 40px; height: 40px; margin-bottom: 5px;"></div>  </div> <div style="text-align: center;"> <div style="border: 1px solid black; width: 40px; height: 40px; margin-bottom: 5px;"></div>  </div> <div style="text-align: center;"> <div style="border: 1px solid black; width: 40px; height: 40px; margin-bottom: 5px;"></div>  </div> </div>





ល្បែងគូសតាមស្នាមចុច(ស្រះ (្ក)និង  
 ផាត់ពណ័រូបភាព

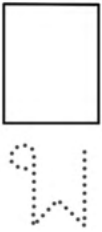
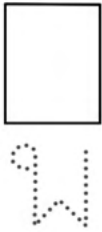

ស្កេន QR Code

សាលាមត្តេយ្យ ..... ថ្នាក់កម្រិត .....

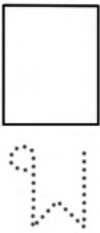
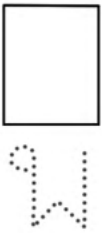
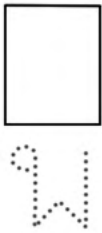
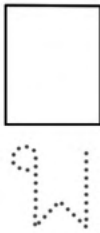
ឈ្មោះ: ..... កាលបរិច្ឆេទ .....

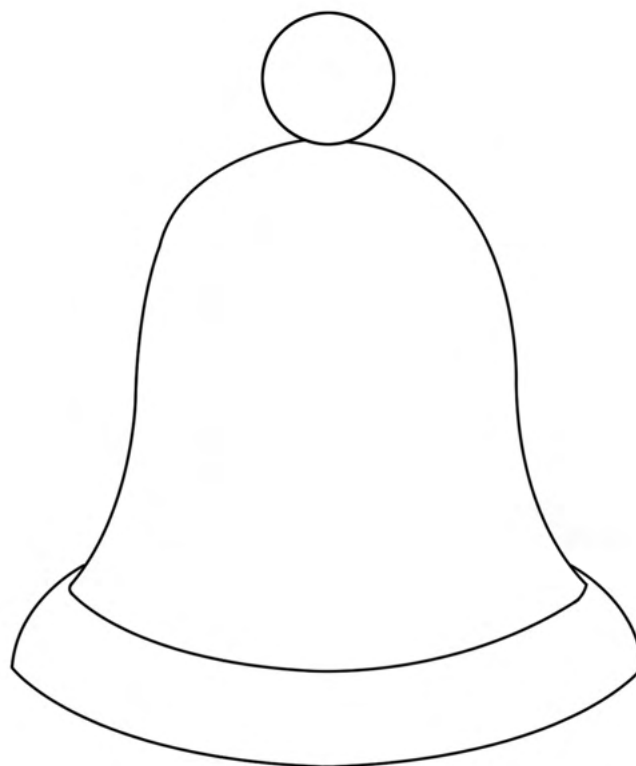
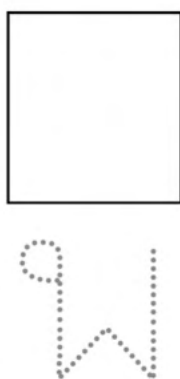
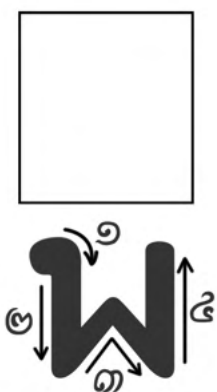

ជូង



ចំណាងដើម្បី: ស្ថាប័ន (១) និង ផ្ទះ (១)



ស្កេន QR Code

សាលាមត្តេយ្យ ..... ថ្នាក់កម្រិត .....

ឈ្មោះ: ..... កាលបរិច្ឆេទ .....

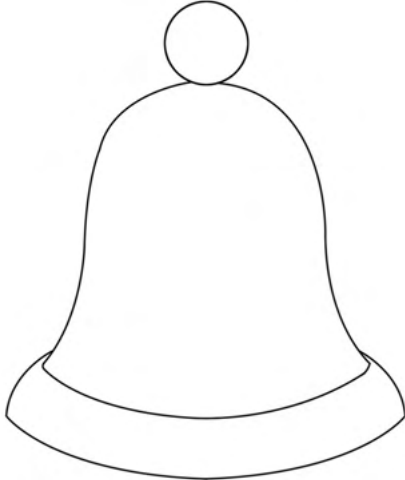
<p>១ . ដាក់ពណ៌ស្រះ: (១)</p>  	<p>២ . គូររង្វង់ស្រះ: (១) និង ដាក់ពណ៌រូបភាព</p>  <p style="text-align: center;">ជូង</p> <div style="display: flex; justify-content: space-around;"> <div style="border: 1px solid black; width: 40px; height: 40px; margin-bottom: 5px;"></div> <div style="font-size: 24px; margin-bottom: 5px;">១</div> </div> <div style="display: flex; justify-content: space-around;"> <div style="border: 1px solid black; width: 40px; height: 40px; margin-bottom: 5px;"></div> <div style="font-size: 24px; margin-bottom: 5px;">២</div> </div> <div style="display: flex; justify-content: space-around;"> <div style="border: 1px solid black; width: 40px; height: 40px; margin-bottom: 5px;"></div> <div style="font-size: 24px; margin-bottom: 5px;">៣</div> </div>
<p>៣ . គូសតាមស្នាមចុចស្រះ: (១)</p> <div style="display: grid; grid-template-columns: repeat(4, 1fr); gap: 10px;"> <!-- Row 1 --> <div style="border: 1px solid black; width: 40px; height: 40px;"></div> <div style="border: 1px solid black; width: 40px; height: 40px;"></div> <div style="border: 1px solid black; width: 40px; height: 40px;"></div> <div style="border: 1px solid black; width: 40px; height: 40px;"></div> <!-- Row 2 --> <div style="font-size: 24px;">ឃ</div> <div style="font-size: 24px;">ឃ</div> <div style="font-size: 24px;">ឃ</div> <div style="font-size: 24px;">ឃ</div> <!-- Row 3 --> <div style="border: 1px solid black; width: 40px; height: 40px;"></div> <div style="border: 1px solid black; width: 40px; height: 40px;"></div> <div style="border: 1px solid black; width: 40px; height: 40px;"></div> <div style="border: 1px solid black; width: 40px; height: 40px;"></div> <!-- Row 4 --> <div style="font-size: 24px;">ឃ</div> <div style="font-size: 24px;">ឃ</div> <div style="font-size: 24px;">ឃ</div> <div style="font-size: 24px;">ឃ</div> <!-- Row 5 --> <div style="border: 1px solid black; width: 40px; height: 40px;"></div> <div style="border: 1px solid black; width: 40px; height: 40px;"></div> <div style="border: 1px solid black; width: 40px; height: 40px;"></div> <div style="border: 1px solid black; width: 40px; height: 40px;"></div> <!-- Row 6 --> <div style="font-size: 24px;">ឃ</div> <div style="font-size: 24px;">ឃ</div> <div style="font-size: 24px;">ឃ</div> <div style="font-size: 24px;">ឃ</div> </div>	<p>៤ . គូររង្វង់ជុំវិញស្រះ: (១)</p> <div style="display: grid; grid-template-columns: repeat(5, 1fr); gap: 10px;"> <!-- Row 1 --> <div style="border: 1px solid black; width: 40px; height: 40px;"></div> <div style="border: 1px solid black; width: 40px; height: 40px;"></div> <div style="border: 1px solid black; width: 40px; height: 40px;"></div> <div style="border: 1px solid black; width: 40px; height: 40px;"></div> <div style="border: 1px solid black; width: 40px; height: 40px;"></div> <!-- Row 2 --> <div style="font-size: 24px;">ឃ</div> <div style="font-size: 24px;">១</div> <div style="font-size: 24px;">៣</div> <div style="font-size: 24px;">០</div> <div style="font-size: 24px;">៣</div> <!-- Row 3 --> <div style="border: 1px solid black; width: 40px; height: 40px;"></div> <div style="border: 1px solid black; width: 40px; height: 40px;"></div> <div style="border: 1px solid black; width: 40px; height: 40px;"></div> <div style="border: 1px solid black; width: 40px; height: 40px;"></div> <div style="border: 1px solid black; width: 40px; height: 40px;"></div> <!-- Row 4 --> <div style="font-size: 24px;">៣</div> <div style="font-size: 24px;">១</div> <div style="font-size: 24px;">ឃ</div> <div style="font-size: 24px;">៣</div> <div style="font-size: 24px;">០</div> <!-- Row 5 --> <div style="border: 1px solid black; width: 40px; height: 40px;"></div> <div style="border: 1px solid black; width: 40px; height: 40px;"></div> <div style="border: 1px solid black; width: 40px; height: 40px;"></div> <div style="border: 1px solid black; width: 40px; height: 40px;"></div> <div style="border: 1px solid black; width: 40px; height: 40px;"></div> <!-- Row 6 --> <div style="font-size: 24px;">០</div> <div style="font-size: 24px;">៣</div> <div style="font-size: 24px;">០</div> <div style="font-size: 24px;">៣</div> <div style="font-size: 24px;">០</div> <!-- Row 7 --> <div style="border: 1px solid black; width: 40px; height: 40px;"></div> <div style="border: 1px solid black; width: 40px; height: 40px;"></div> <div style="border: 1px solid black; width: 40px; height: 40px;"></div> <div style="border: 1px solid black; width: 40px; height: 40px;"></div> <div style="border: 1px solid black; width: 40px; height: 40px;"></div> <!-- Row 8 --> <div style="font-size: 24px;">ឃ</div> <div style="font-size: 24px;">០</div> <div style="font-size: 24px;">ឃ</div> <div style="font-size: 24px;">៣</div> <div style="font-size: 24px;">០</div> </div>

# ល្បែងគូសភ្ជាប់ស្រៈទៅនឹងរូបភាព និងផាត់ពណ៌



ស្កេន QR Code

សាលាមត្តេយ្យ ..... ថ្នាក់កម្រិត .....

ឈ្មោះ: ..... កាលបរិច្ឆេទ .....

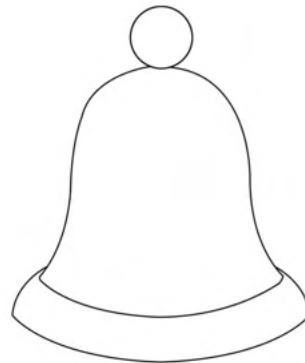
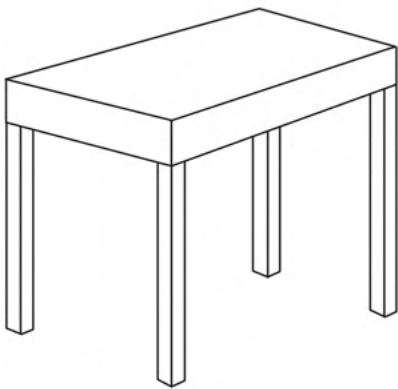
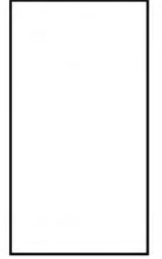

តុ

ឈី

ជូង

ថ្ន



# រកចំណុចខុសគ្នាចំនួន ប្រាំមួយ រវាងរូបទាំងពីរ និងគូររង្វង់លើរូបភាពនោះ



ស្កែន QR Code

សាលាមត្តេយ្យ ..... ថ្នាក់កម្រិត .....

ឈ្មោះ: ..... កាលបរិច្ឆេទ .....

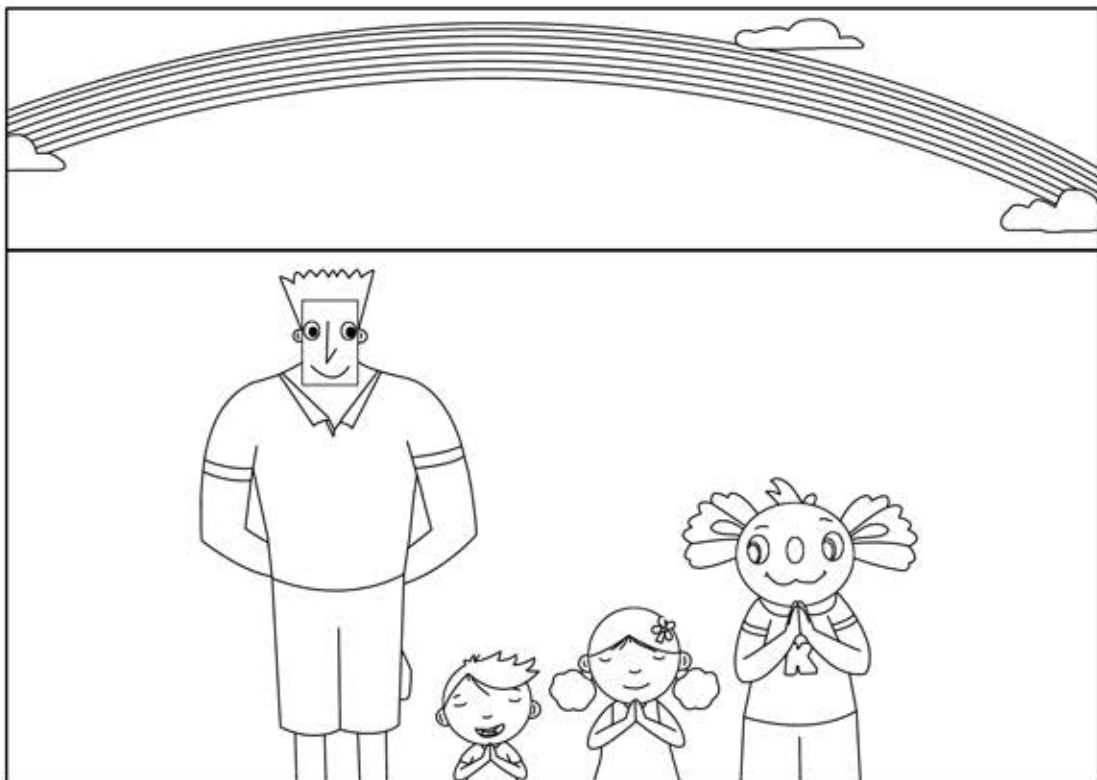
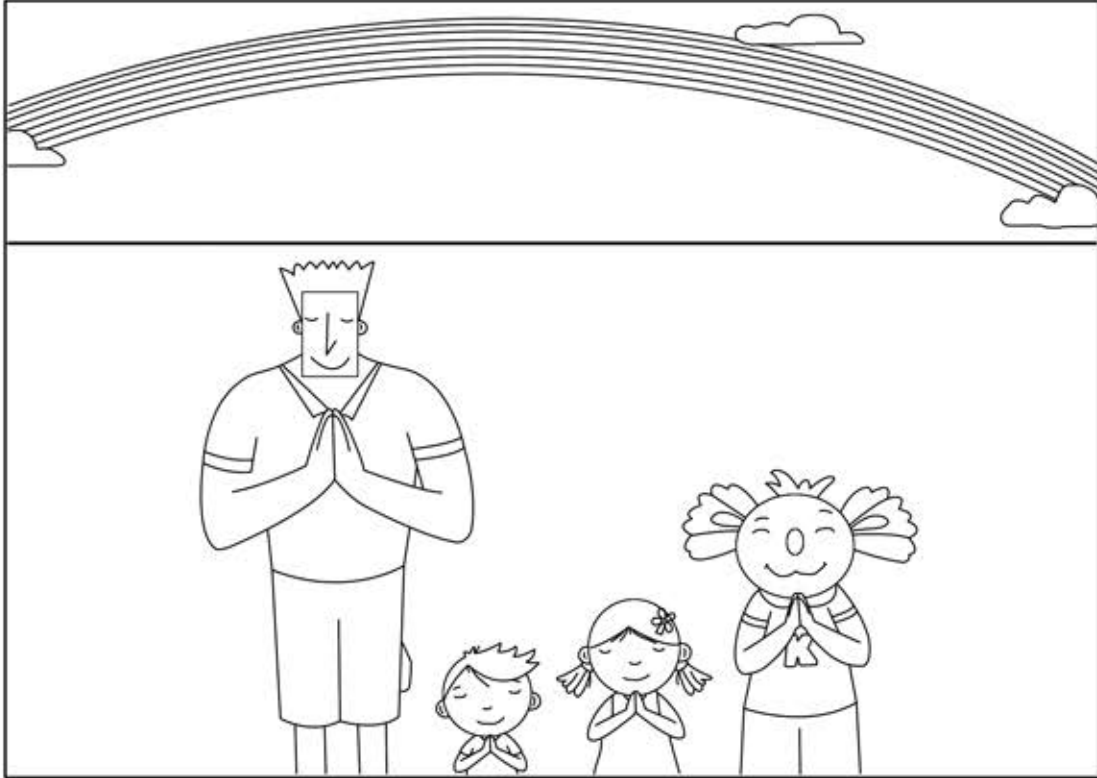

ល្បែងគូសតាមស្នាមចុច(ស្រ: (រឺ)) និង  
 ផាត់ពណ័រូបភាព



ស្កេន QR Code

សាលាមត្តេយ្យ ..... ថ្នាក់កម្រិត .....

ឈ្មោះ: ..... កាលបរិច្ឆេទ .....

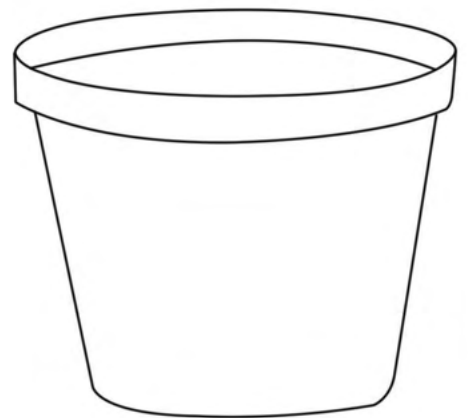
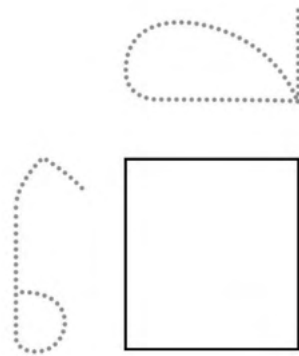
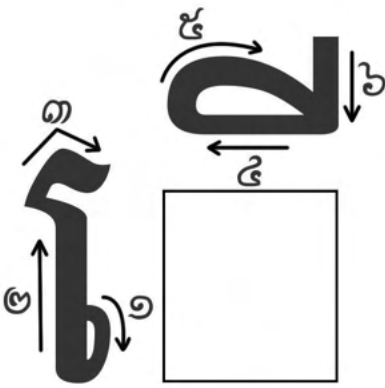
ដើម

# ស្ថាវ (ស្រៈ: ើ) និង ផាត់ពណ៌



ស្កេន QR Code

សាលាមត្តេយ្យ ..... ថ្នាក់កម្រិត .....

ឈ្មោះ: ..... កាលបរិច្ឆេទ .....

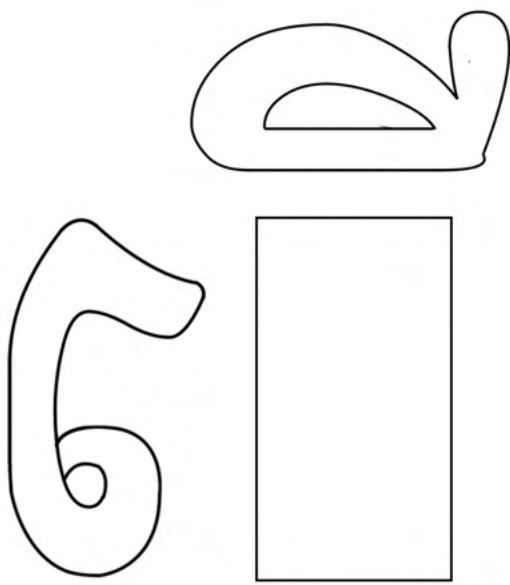
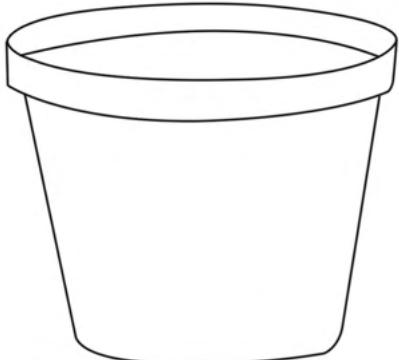
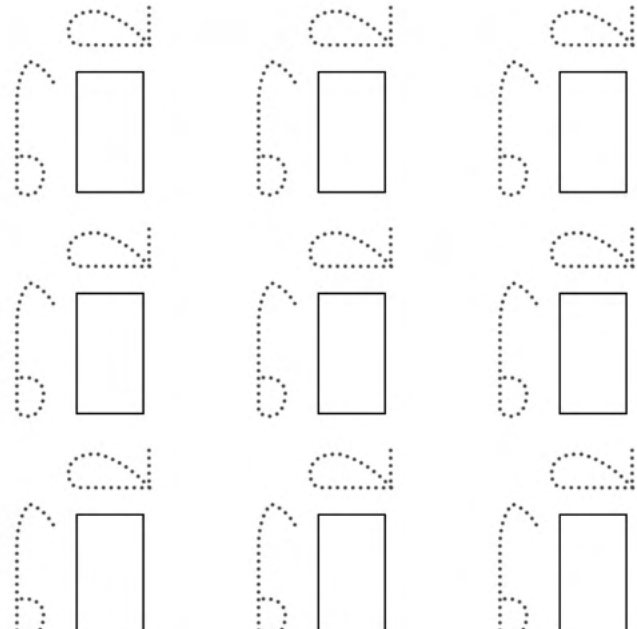
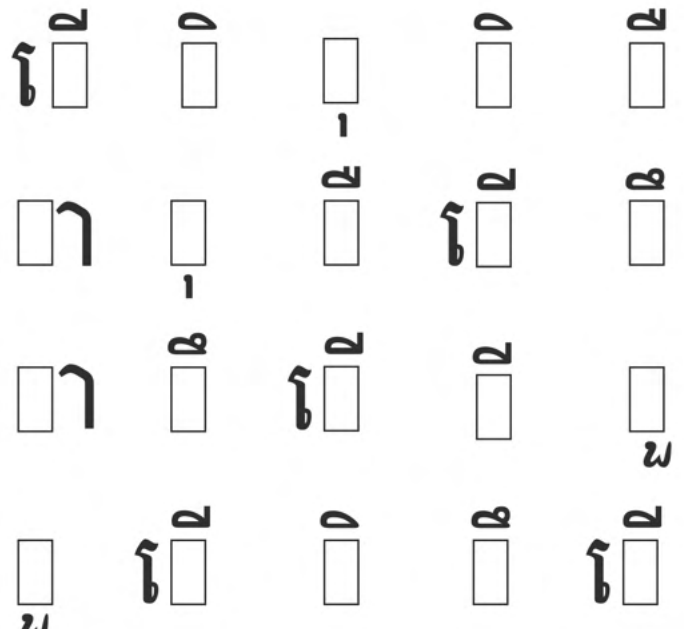
<p>១ . ផាត់ពណ៌ស្រៈ: (ើ)</p>	<p>២ . គូររង្វង់ស្រៈ: (ើ) និង ផាត់ពណ៌រូបភាព</p>	
	 <p>ងើង</p>	<p>ើ <input type="checkbox"/></p> <p>ង <input type="checkbox"/></p> <p>ង <input type="checkbox"/></p>
<p>៣ . គូសតាមស្នាមចុចស្រៈ: (ើ)</p>	<p>៤ . គូររង្វង់ជុំវិញស្រៈ: (ើ)</p>	
		

ល្បែងគូសតាមស្នាមចុច(ស្រ: (ឆ្នើ)) និង  
 ដាត់ពណ៌រូបភាព



ស្ត្រីន QR Code

សាលាមត្តេយ្យ ..... ថ្នាក់កម្រិត .....

ឈ្មោះ: ..... កាលបរិច្ឆេទ .....

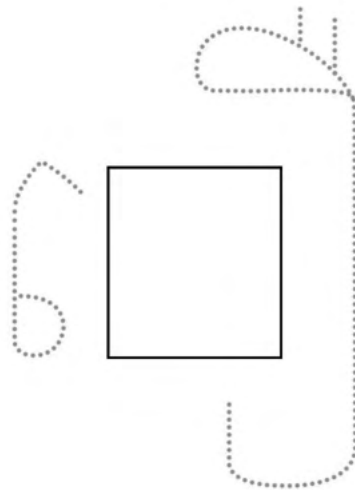
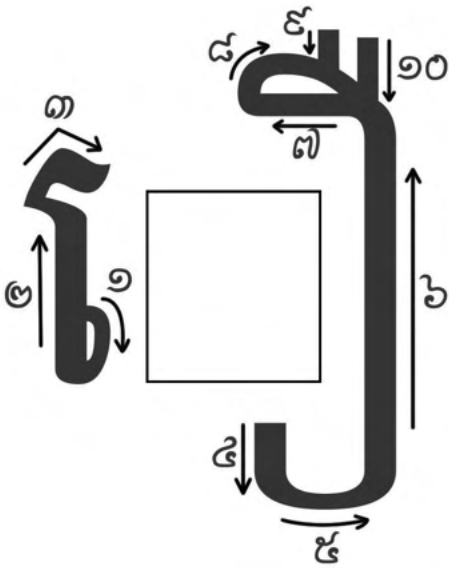
ឆ្នើ

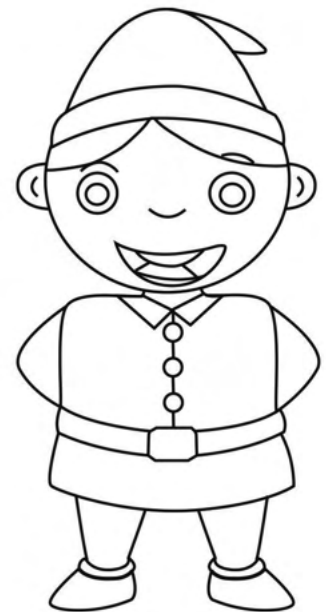

ស្ថាប័ន (ស្រី) និង ផ្កាត្រី



ស្កេន QR Code

សាលាមត្តេយ្យ ..... ថ្នាក់កម្រិត .....

ឈ្មោះ ..... កាលបរិច្ឆេទ .....

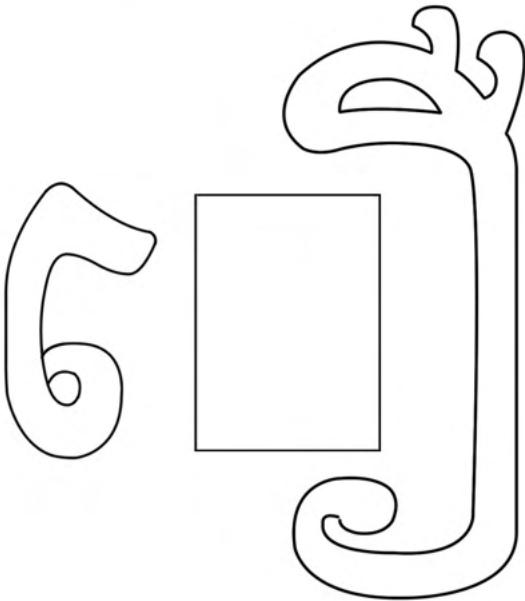
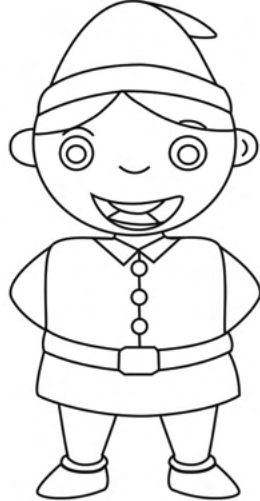
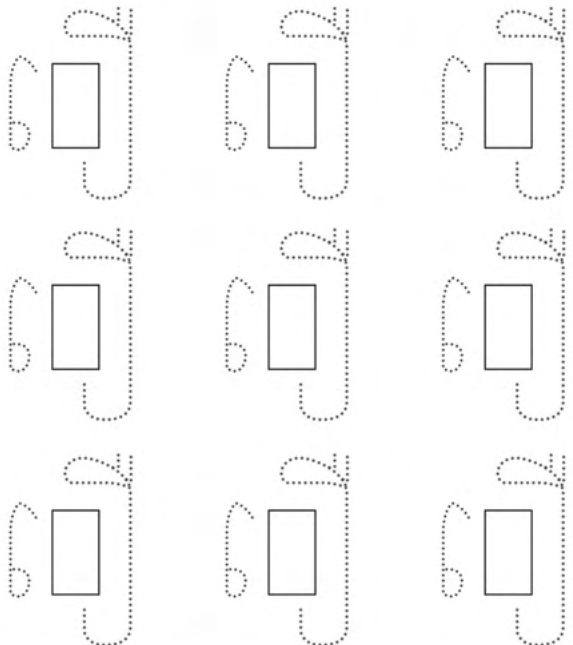
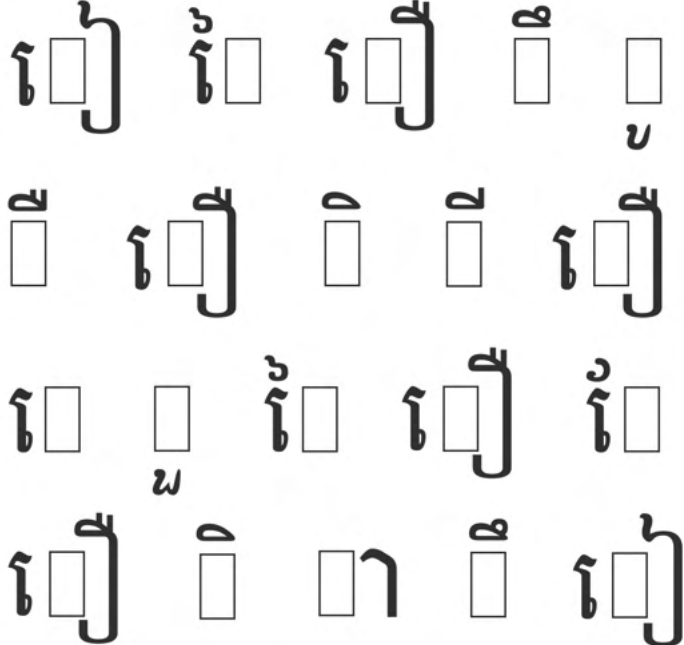
<p>១ . ផ្កាត្រី (ស្រី)</p>	<p>២ . គូររង្វង់ (ស្រី) និង ផ្កាត្រីរូបភាព</p>	
	 <p>ស្រី</p>	<p>ស្រី</p> <p>ស្រី</p> <p>ស្រី</p>
<p>៣ . គូសតាមស្នាមចុច (ស្រី)</p>	<p>៤ . គូររង្វង់ជុំវិញ (ស្រី)</p>	
		

ល្បែងគូសតាមស្នាមចុច(ស្រះ (ទៀប) និង ផាត់ពណ័រូបភាព



ស្កេន QR Code

សាលាមត្តេយ្យ ..... ថ្នាក់កម្រិត .....

ឈ្មោះ: ..... កាលបរិច្ឆេទ .....

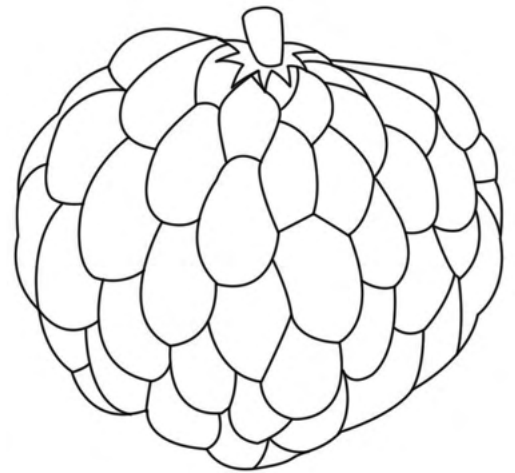
ទៀប

ស្ថាប័ន (ស្រះ) និង ផ្កាត័ពណ៍



ស្កេន QR Code

សាលាមត្តេយ្យ ..... ថ្នាក់កម្រិត .....

ឈ្មោះ ..... កាលបរិច្ឆេទ .....

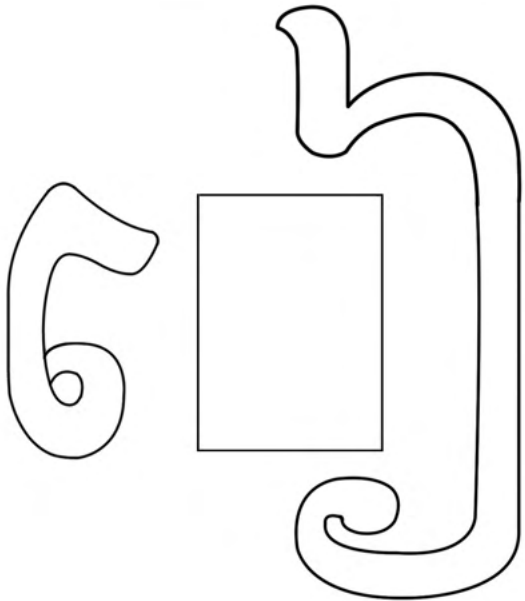
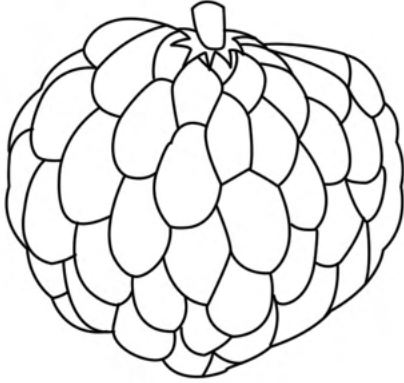
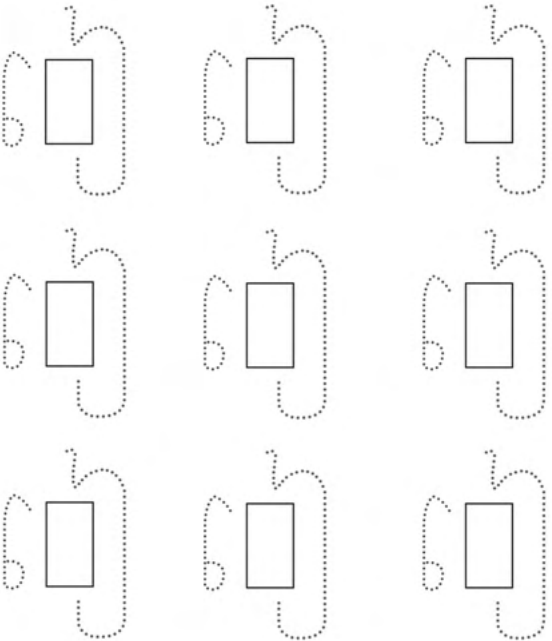
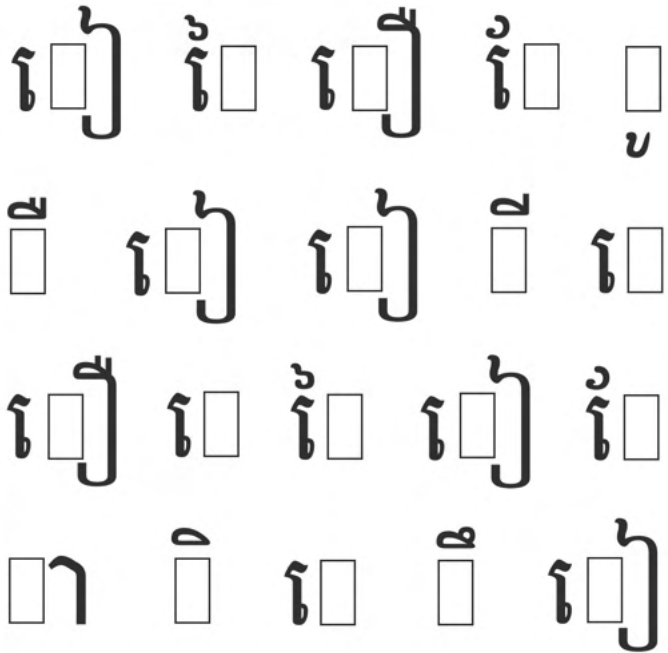
<p>១ . ផ្កាត័ពណ៍ស្រះ (រៀប)</p>	<p>២ . គូររង្វង់ស្រះ (រៀប) និង ផ្កាត័ពណ៍រូបភាព</p>	
	 <p>រៀប</p>	<p>រៀ</p> <p>រៀ</p> <p>រៀ</p>
<p>៣ . គូសតាមស្នាមចុចស្រះ (រៀប)</p>	<p>៤ . គូររង្វង់ជុំវិញស្រះ (រៀប)</p>	
		

ល្បែងគូសតាមស្នាមចុច(ស្រះ (៤០) និង ផាត់ពណ័រូបភាព



ស្កេន QR Code

សាលាមត្តេយ្យ ..... ផ្នែកកម្រិត .....

ឈ្មោះ: ..... កាលបរិច្ឆេទ .....

<input type="checkbox"/>	<input type="checkbox"/>	<input type="checkbox"/>	<input type="checkbox"/>	<input type="checkbox"/>
<input type="checkbox"/>	<input type="checkbox"/>	<input type="checkbox"/>	<input type="checkbox"/>	<input type="checkbox"/>

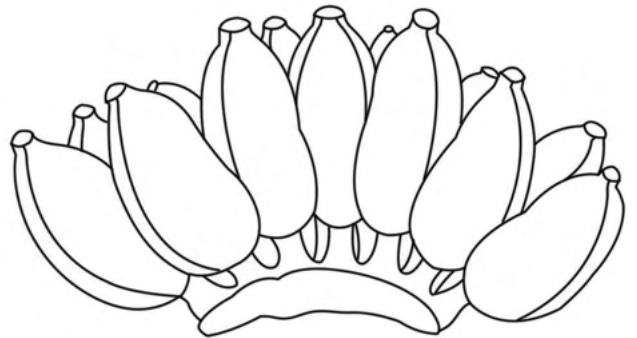

ថែកី



# ស្ទាស់(ស្រះ: (១០) និងដាត់ពណ៍



ស្កេន QR Code

សាលាមត្តេយ្យ ..... ថ្នាក់កម្រិត .....

ឈ្មោះ: ..... កាលបរិច្ឆេទ .....

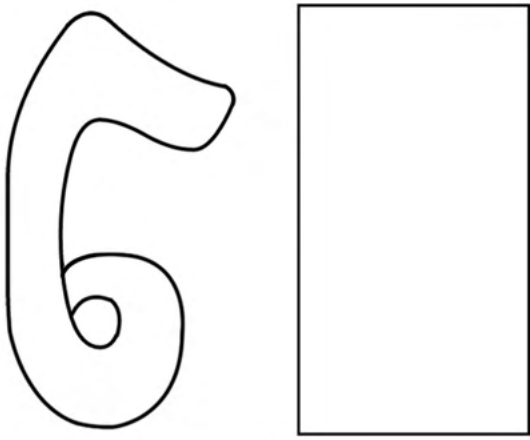
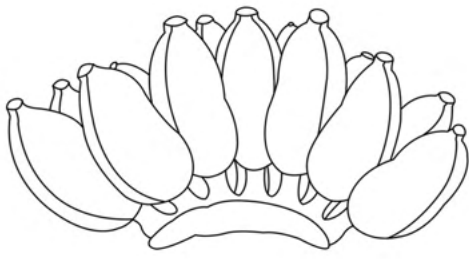
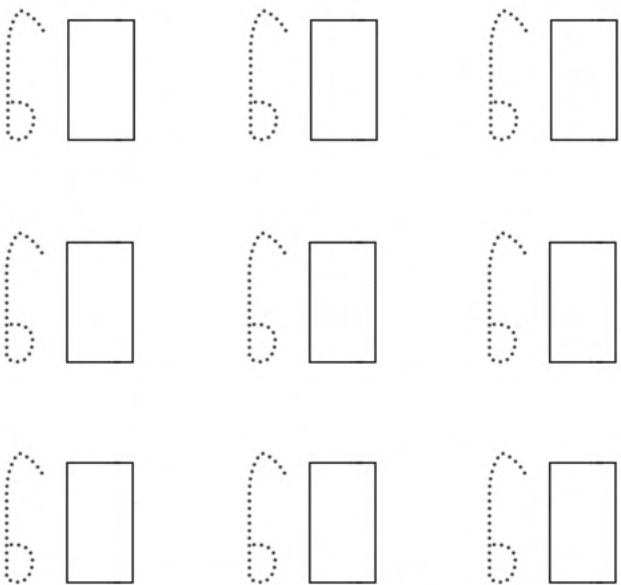
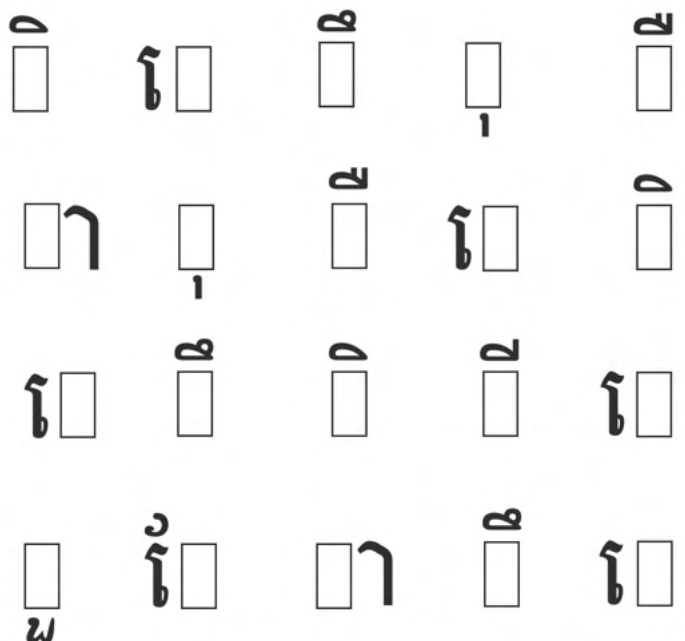
<p>១ .ដាត់ពណ៍ស្រះ: (១០)</p>	<p>២ .គូររង្វង់ស្រះ: (១០) និងដាត់ពណ៍រូបភាព</p>	
	 <p>ចេក</p>	<p>ស <input type="checkbox"/></p> <p>ស <input type="checkbox"/></p> <p>ស <input type="checkbox"/></p>
<p>៣ .គូសតាមស្នាមចុចស្រះ: (១០)</p>	<p>៤ .គូររង្វង់ជុំវិញស្រះ: (១០)</p>	
		

# ល្បែងគូសភ្ជាប់ (ស្រែះទៅនឹងរូបភាព និងផ្លាស់តំណ)



ស្កេន QR Code

សាលាមត្តេយ្យ ..... ថ្នាក់កម្រិត .....

ឈ្មោះ: ..... កាលបរិច្ឆេទ .....

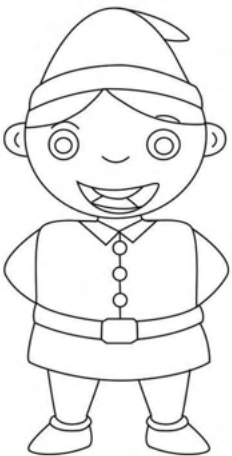
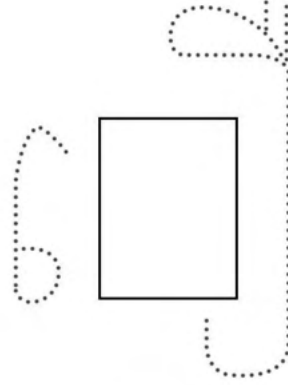
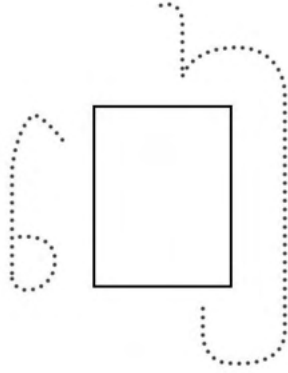
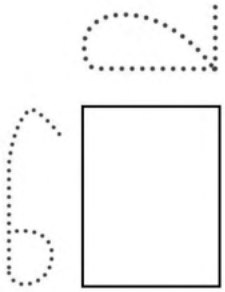

ត្បើ



ដើង

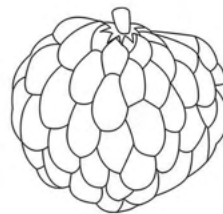

ទៀប



ចេក

# ល្បែងដើរវង្វេង

សាលាមត្តេយ្យ ..... ថ្នាក់កម្រិត .....

ឈ្មោះ : ..... កាលបរិច្ឆេទ .....



ស្កេន QR Code

## ផែនទីប្រទេសកម្ពុជា លី

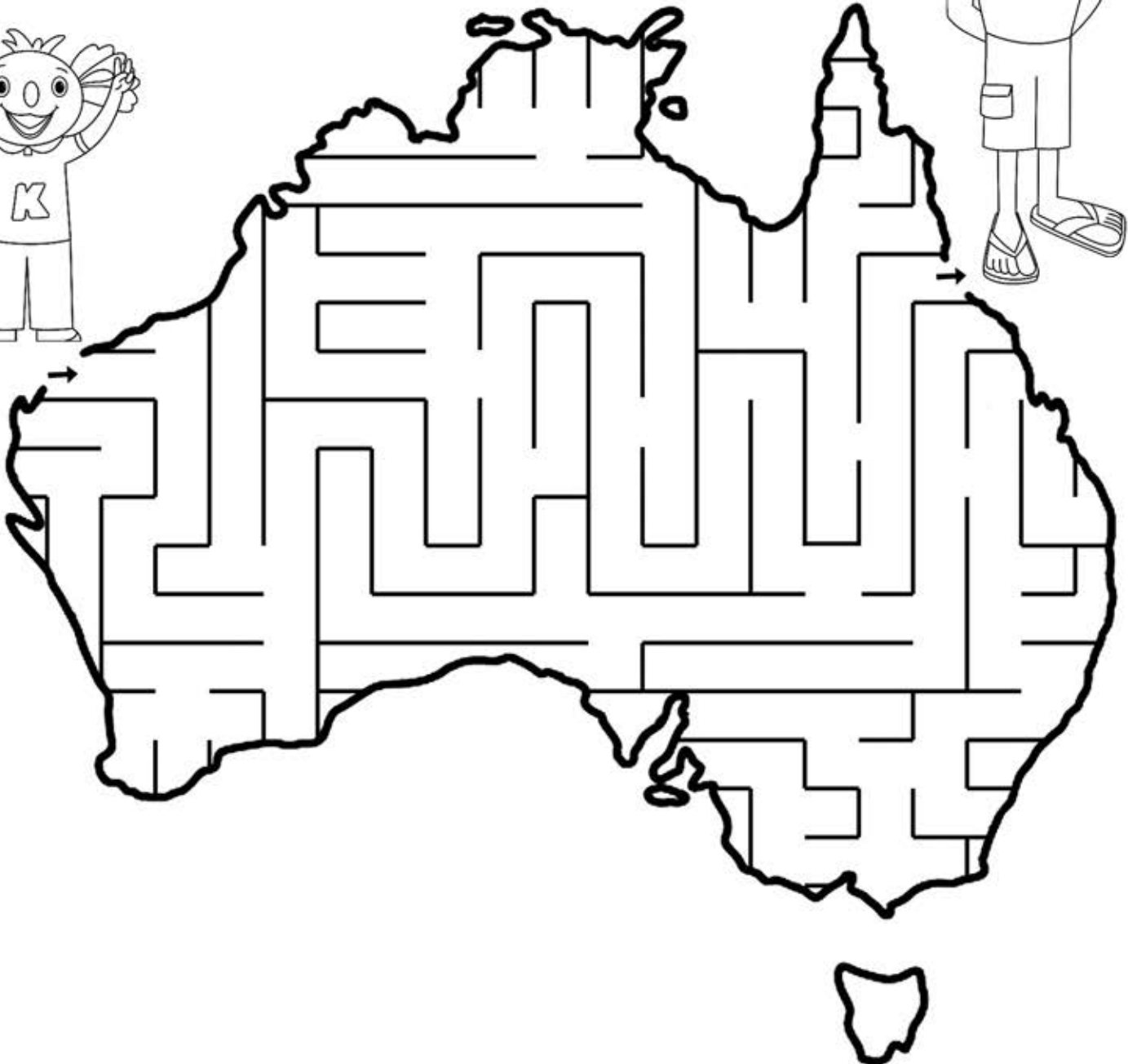
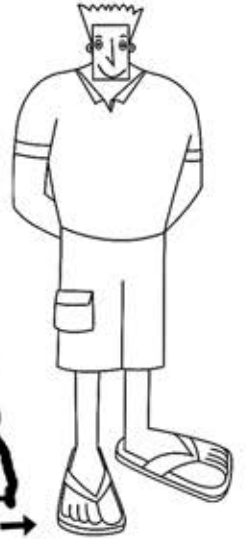

ល្បែងគូសតាមស្នាមចុច(ស្រ: (រំ) និង  
 ផាត់ពណ័រូបភាព



ស្កែន QR Code

សាលាមត្តេយ្យ ..... ថ្នាក់កម្រិត .....

ឈ្មោះ: ..... កាលបរិច្ឆេទ .....

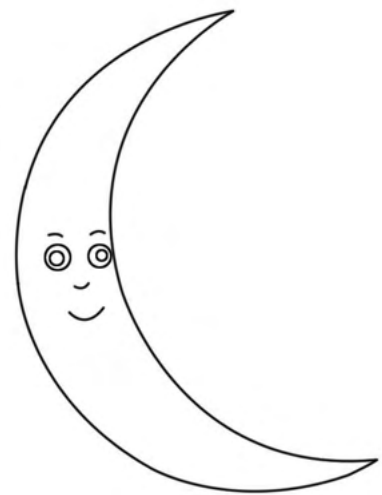
រំ

# ស្ថាប័ន (រូប) និង ជាតិ ពណ៌



ស្កេន QR Code

សាលាមត្តេយ្យ ..... ថ្នាក់កម្រិត .....

ឈ្មោះ ..... កាលបរិច្ឆេទ .....

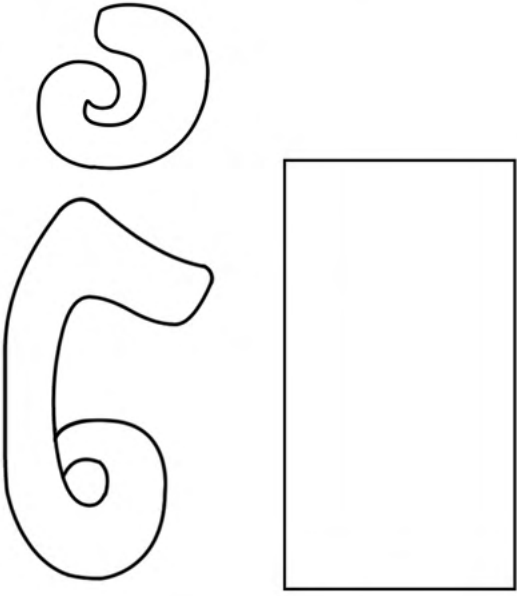
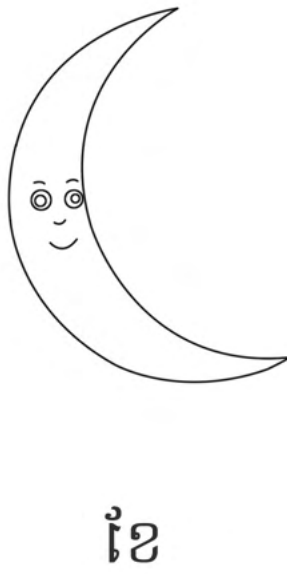
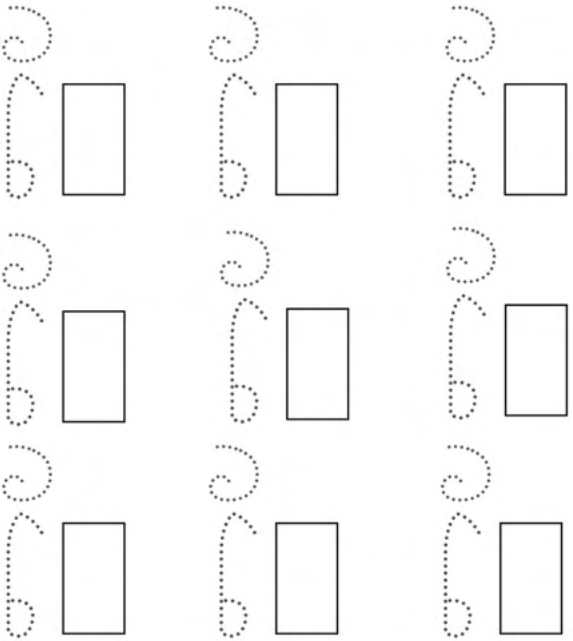
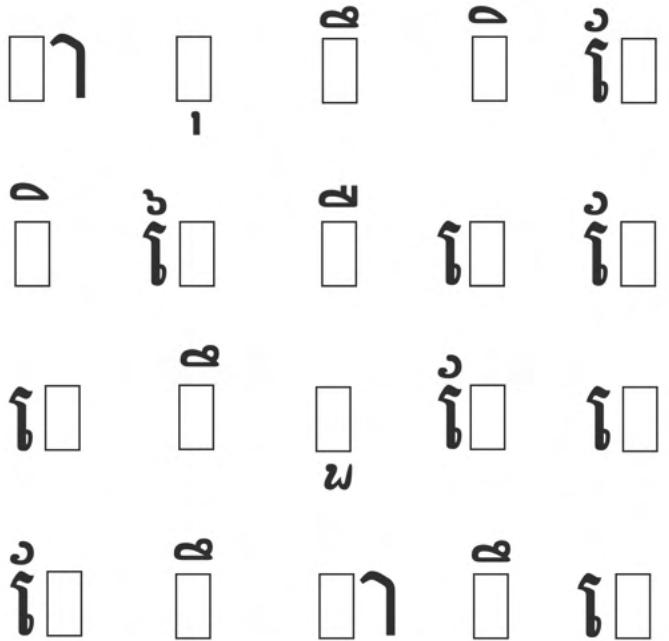
<p>១ . ជាតិ ពណ៌ រូប (រូប)</p>	<p>២ . គូររង្វង់ រូប (រូប) និង ជាតិ ពណ៌ រូប ភាព</p>	
		<p>រ <input type="checkbox"/></p> <p>ខ <input type="checkbox"/></p> <p>ខែ <input type="checkbox"/></p>
<p>៣ . គូសតាមស្នាមចុច រូប (រូប)</p>	<p>៤ . គូររង្វង់ជុំវិញ រូប (រូប)</p>	
		

ល្បែងគូសតាមស្នាមចុច(ស្រ: ៃ) និង  
 ដាត់ពណ័រូបភាព



ស្កេន QR Code

សាលាមត្តេយ្យ ..... ថ្នាក់កម្រិត .....

ឈ្មោះ: ..... កាលបរិច្ឆេទ .....

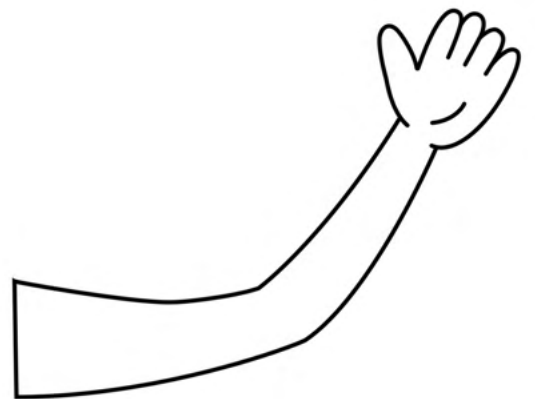
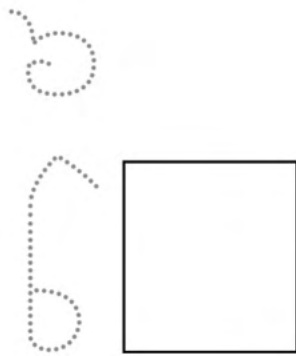
ដៃ

# ស្ថានស្រី (ខ្មែរ) និងជាតិពណ៌



ស្កេន QR Code

សាលាមត្តេយ្យ ..... ថ្នាក់កម្រិត .....

ឈ្មោះ: ..... កាលបរិច្ឆេទ .....

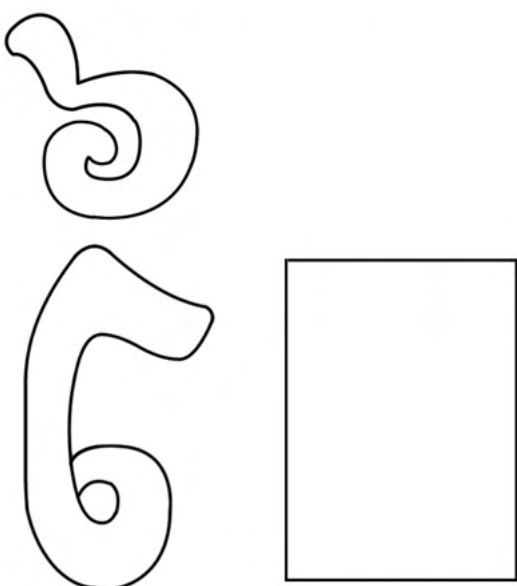
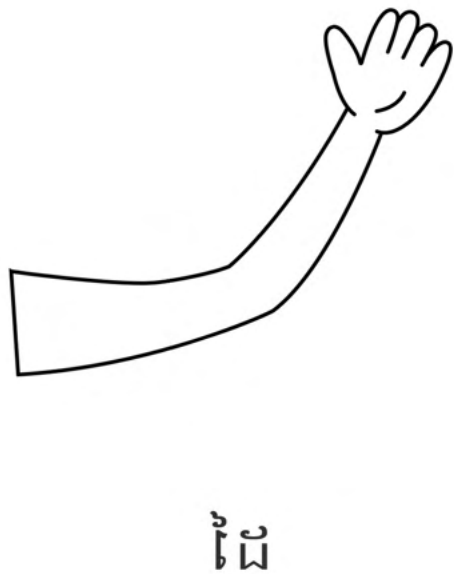
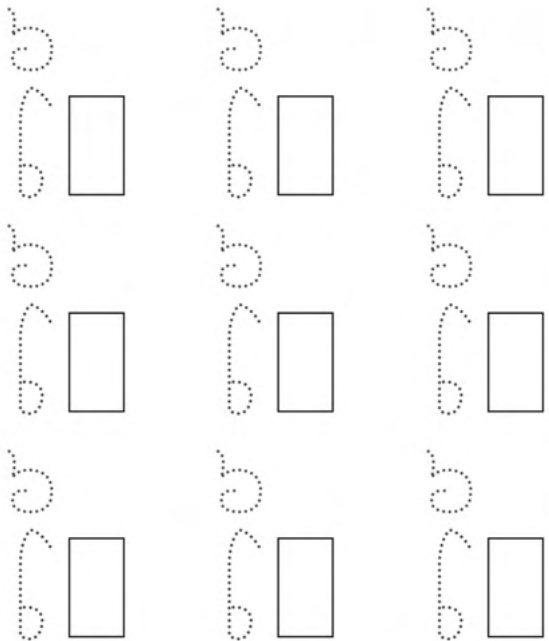
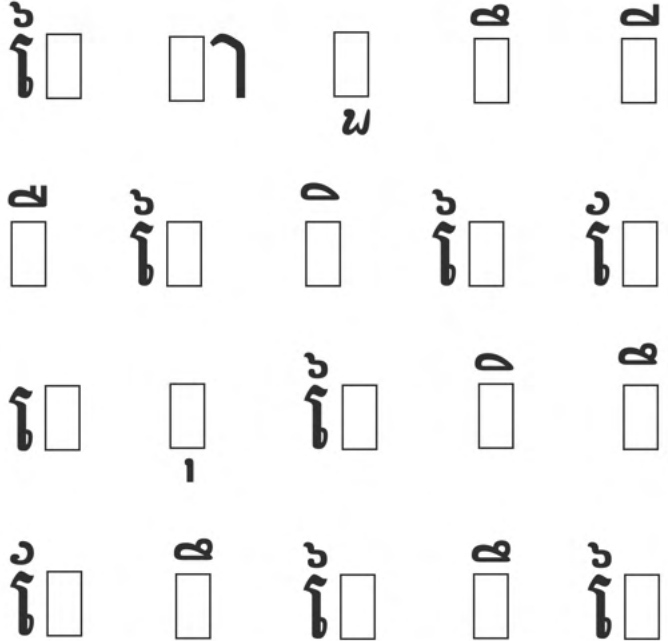
<p>១ . ជាតិពណ៌ស្រី: (ខ្មែរ)</p>	<p>២ . គូររង្វង់ស្រី: (ខ្មែរ) និងជាតិពណ៌រូបភាព</p>	
		<p>ស្រី <input type="checkbox"/></p> <p>ដៃ <input type="checkbox"/></p>
<p>៣ . គូសតាមស្នាមចុចស្រី: (ខ្មែរ)</p>	<p>៤ . គូររង្វង់ជុំវិញស្រី: (ខ្មែរ)</p>	
		

ល្បែងគូសតាមស្នាមចុច(ស្រ: (១៦) និង  
 ផាត់ពណ័រូបភាព



ស្កែន QR Code

សាលាមត្តេយ្យ ..... ថ្នាក់កម្រិត .....

ឈ្មោះ: ..... កាលបរិច្ឆេទ .....

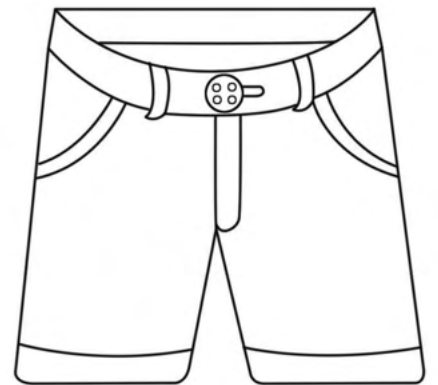
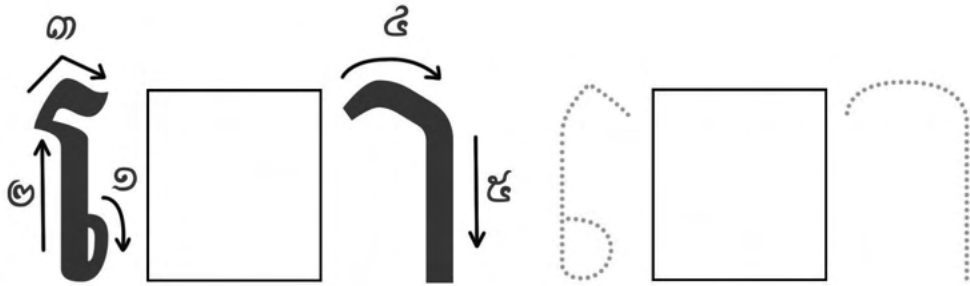
ខោ



# ស្ថាវ័រ(ស្រៈ: ១០១) និងជាត់៧ណី



ស្កេន QR Code

សាលាមត្តេយ្យ ..... ថ្នាក់កម្រិត .....

ឈ្មោះ: ..... កាលបរិច្ឆេទ .....

<p>១ .ជាត់៧ណីស្រៈ: (១០១)</p>	<p>២ .គូររង្វង់ស្រៈ: (១០១) និងជាត់៧ណីរូបភាព</p>		
		<p>ទោ</p>	
		<p>ខោ</p>	<p>ទៀ</p>
			<p>ទៅ</p>
<p>៣ .គូសតាមស្នាមចុចស្រៈ: (១០១)</p>	<p>៤ .គូររង្វង់ជុំវិញស្រៈ: (១០១)</p>		

ល្បែងគូសតាមស្នាមចុច(ស្រ: (៤០៧) និង  
 ផាត់ពណ័រូបភាព



ស្កែន QR Code

សាលាមត្តេយ្យ ..... ថ្នាក់កម្រិត .....

ឈ្មោះ: ..... កាលបរិច្ឆេទ .....

តោ	តោ	តោ	តោ	តោ
តោ	តោ	តោ	តោ	តោ

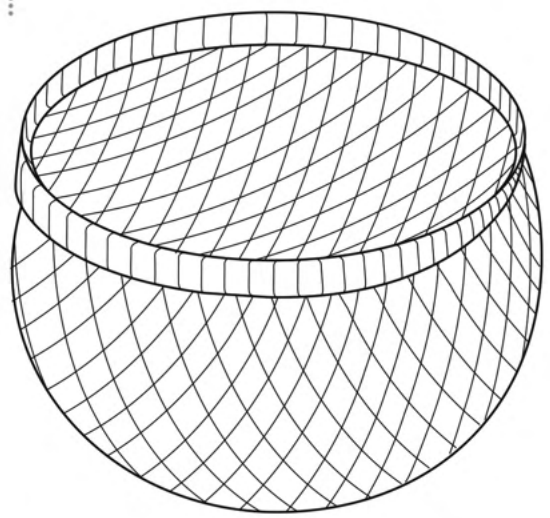
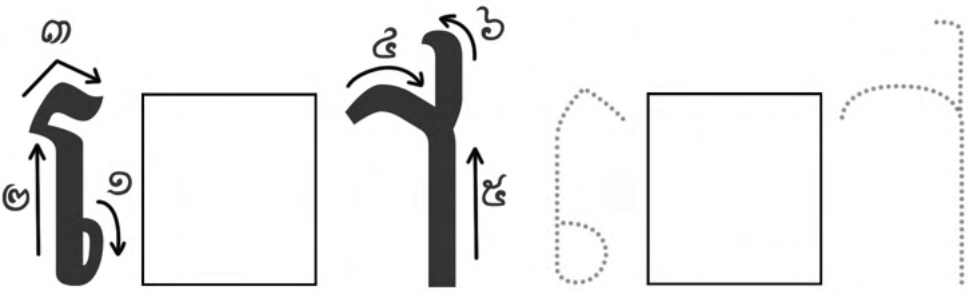

តោ

ស្ថាវ័រ (ស្រី) និង ដាត់ពណ៌



ស្កេន QR Code

សាលាមត្តេយ្យ ..... ថ្នាក់កម្រិត .....

ឈ្មោះ ..... កាលបរិច្ឆេទ .....

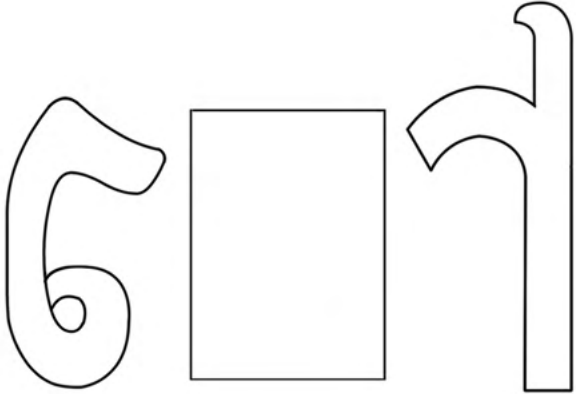
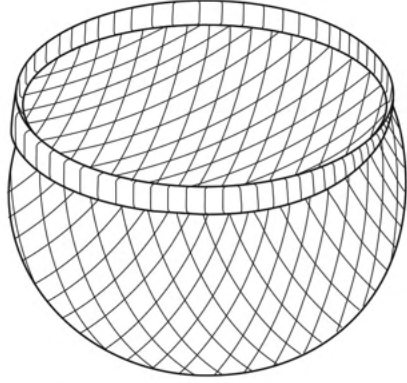
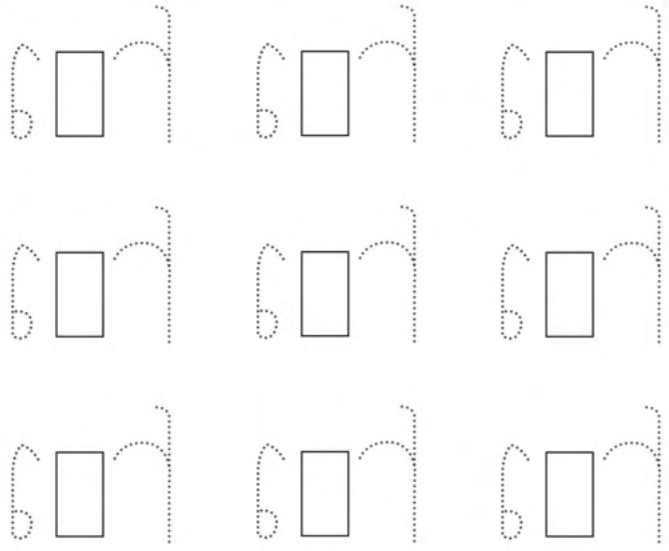
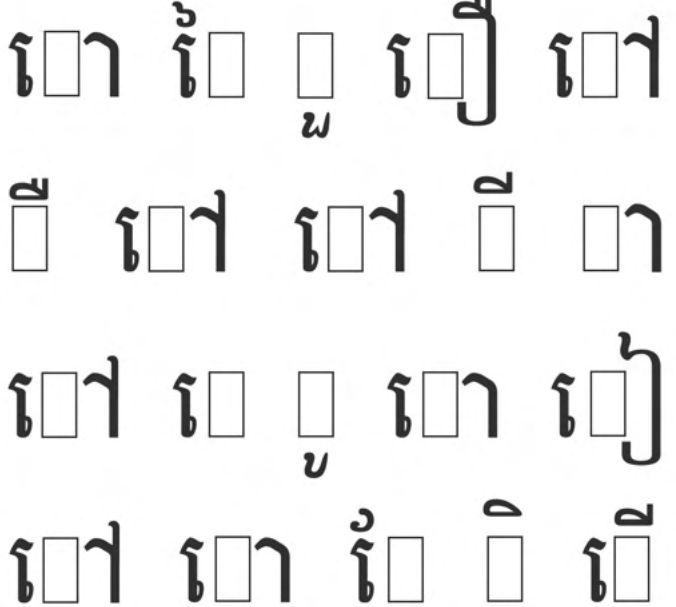
<p>១ .ដាត់ពណ៌ស្រី: (០៧)</p>	<p>២ .គូររង្វង់ស្រី: (០៧) និងដាត់ពណ៌រូបភាព</p>	
	 <p>តោ</p>	<p>ស្រី</p> <p>០៧</p> <p>០៧</p>
<p>៣ .គូសតាមស្នាមចុចស្រី: (០៧)</p>	<p>៤ .គូររង្វង់ជុំវិញស្រី: (០៧)</p>	
		

# ល្បែងគូសភ្ជាប់ស្រៈទៅនឹងរូបភាព និងផ្លាស់ពណ៌



ស្កេន QR Code

សាលាមត្តេយ្យ ..... ថ្នាក់កម្រិត .....

ឈ្មោះ: ..... កាលបរិច្ឆេទ .....

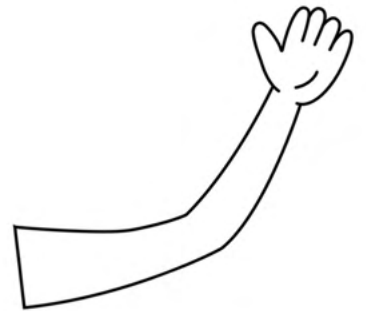
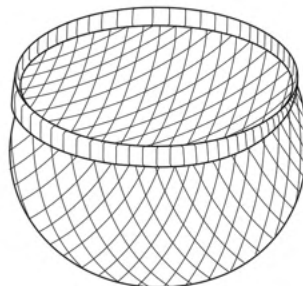
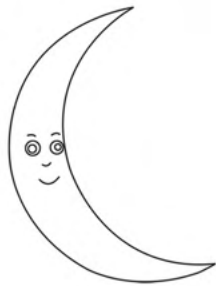
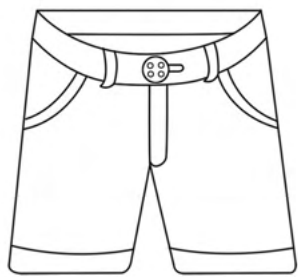
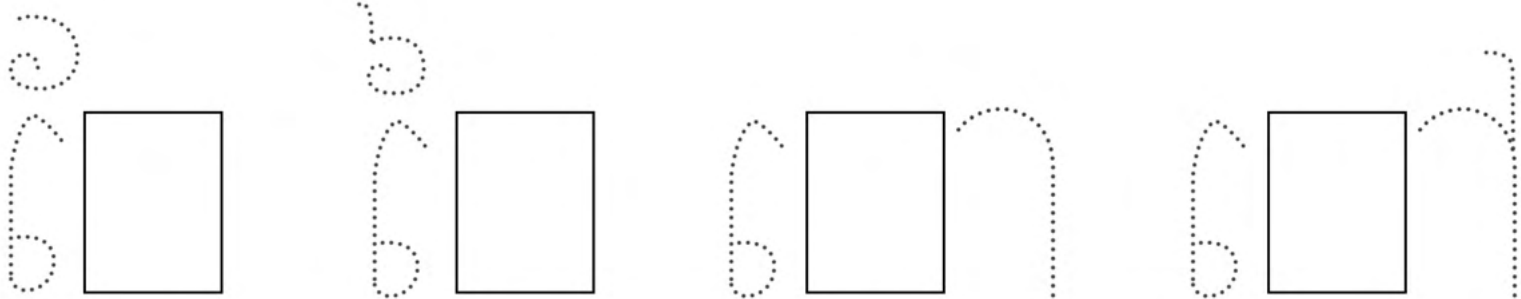

ខោ

ខែ

តោ

ដៃ

# ល្បែងផ្គុំផ្គងសម្លៀកបំពាក់និងរាងកាយ



ស្កេន QR Code

នាមសម្លេង ..... ថ្នាក់កម្រិត .....

ឈ្មោះ : ..... កាលបរិច្ឆេទ .....

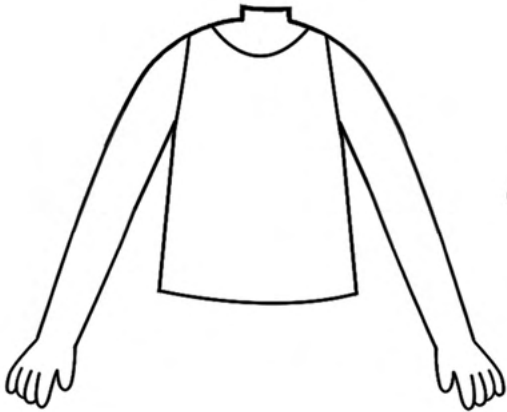
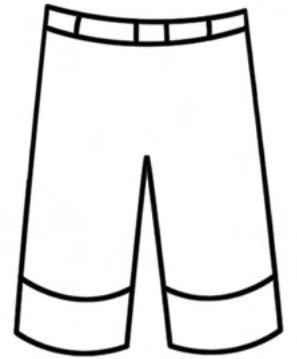
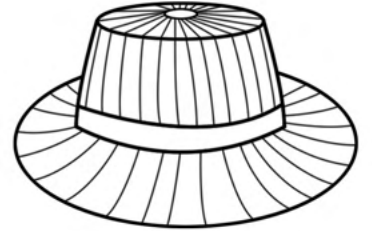
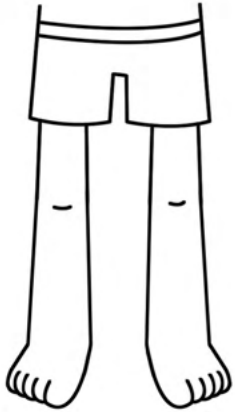

ល្បែងគូសតាមស្នាមចុច(ស្រះ (០) និង ដាត់ពណ័រូបភាព



ស្កេន QR Code

សាលាមត្តេយ្យ ..... ថ្នាក់កម្រិត .....

ឈ្មោះ: ..... កាលបរិច្ឆេទ .....

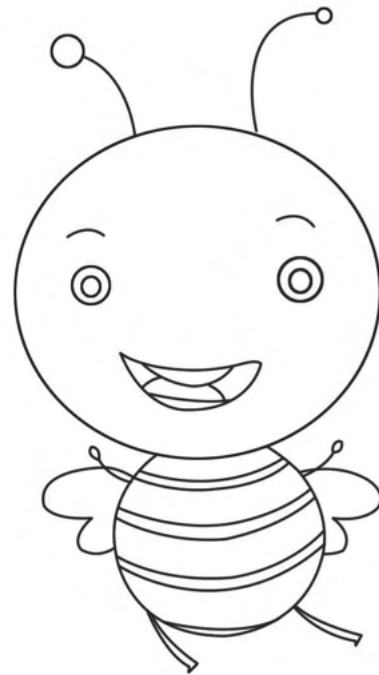
យុំ



# ស្ថាប័ន (០) និង ដាត់ពណ៌



ស្កេន QR Code

សាលាមត្តេយ្យ ..... ថ្នាក់កម្រិត .....

ឈ្មោះ ..... កាលបរិច្ឆេទ .....

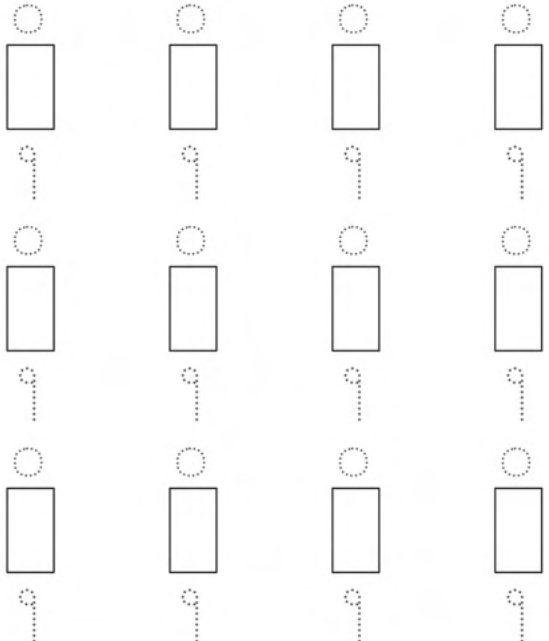
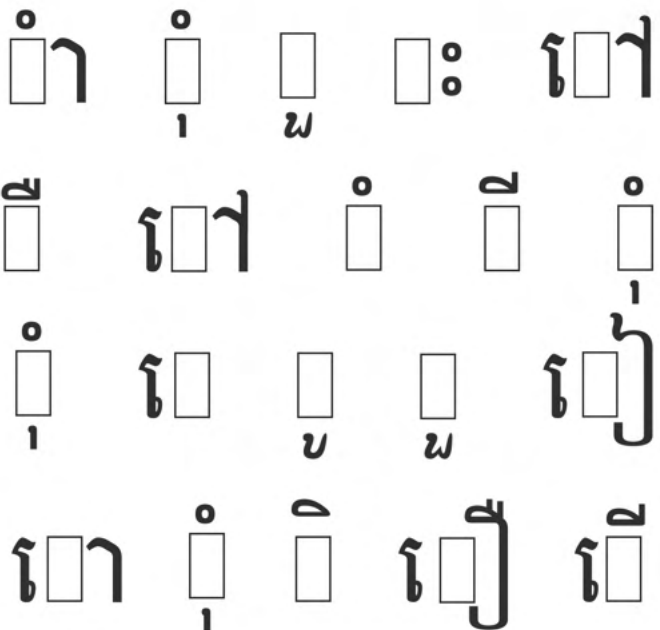
<p>១ .ដាត់ពណ៌ស្រះ: (០)</p>	<p>២ .គូររង្វង់ស្រះ: (០) និងដាត់ពណ៌រូបភាព</p>	
		<div style="border: 1px solid black; padding: 5px; margin-bottom: 5px;"> <input type="text"/>              ១         </div> <div style="border: 1px solid black; padding: 5px; margin-bottom: 5px;"> <input type="text"/>              ០  <input type="text"/> </div> <div style="border: 1px solid black; padding: 5px;"> <input type="text"/>              ០  <input type="text"/>              ១         </div>
<p>៣ .គូសតាមស្នាមចុចស្រះ: (០)</p>	<p>៤ .គូររង្វង់ជុំវិញស្រះ: (០)</p>	
		





# ល្បែងគូសតាមស្នាមចុច(ស្រះ (០) និង ដាត់ពណ័រូបភាព

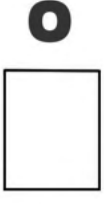
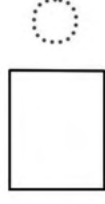
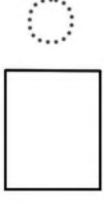
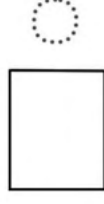

ស្កេន QR Code

សាលាមត្តេយ្យ ..... ថ្នាក់កម្រិត .....

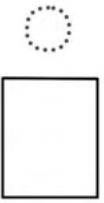
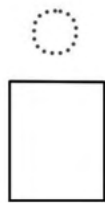
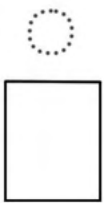
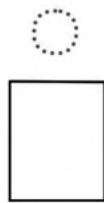
ឈ្មោះ: ..... កាលបរិច្ឆេទ .....



០៧០



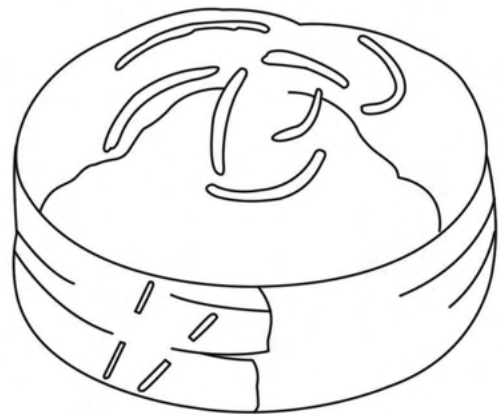



ស្ថាវ័រ (០) និង ជាត់ពណ័រ



ស្កេន QR Code

សាលាមត្តេយ្យ ..... ថ្នាក់កម្រិត .....

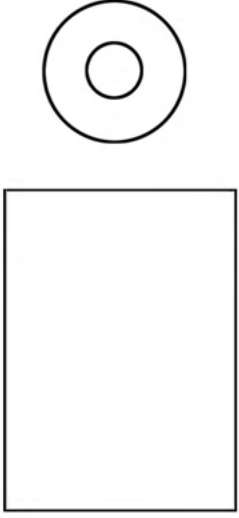
ឈ្មោះ ..... កាលបរិច្ឆេទ .....

<p>១ . ជាត់ពណ័រស្រះ (០)</p> 	<p>២ . គូររង្វង់ស្រះ (០) និង ជាត់ពណ័ររូបភាព</p>  <p style="text-align: center;">ឆ្ា</p> <div style="display: flex; justify-content: space-between; align-items: center;"> <div style="text-align: center;"> <p>០</p> <input style="width: 30px; height: 30px;" type="text"/> </div> <div style="text-align: center;"> <p>០</p> <input style="width: 30px; height: 30px;" type="text"/> <p>១</p> </div> <div style="text-align: center;"> <input style="width: 30px; height: 30px;" type="text"/> <p>២</p> </div> </div>
<p>៣ . គូសតាមស្នាមចុចស្រះ (០)</p> <div style="display: grid; grid-template-columns: repeat(4, 1fr); gap: 20px;"> <!-- Row 1 --> <div style="text-align: center;"><input style="width: 30px; height: 30px; border: 1px dashed gray;" type="text"/></div> <div style="text-align: center;"><input style="width: 30px; height: 30px; border: 1px dashed gray;" type="text"/></div> <div style="text-align: center;"><input style="width: 30px; height: 30px; border: 1px dashed gray;" type="text"/></div> <div style="text-align: center;"><input style="width: 30px; height: 30px; border: 1px dashed gray;" type="text"/></div> <!-- Row 2 --> <div style="text-align: center;"><input style="width: 30px; height: 30px; border: 1px dashed gray;" type="text"/></div> <div style="text-align: center;"><input style="width: 30px; height: 30px; border: 1px dashed gray;" type="text"/></div> <div style="text-align: center;"><input style="width: 30px; height: 30px; border: 1px dashed gray;" type="text"/></div> <div style="text-align: center;"><input style="width: 30px; height: 30px; border: 1px dashed gray;" type="text"/></div> <!-- Row 3 --> <div style="text-align: center;"><input style="width: 30px; height: 30px; border: 1px dashed gray;" type="text"/></div> <div style="text-align: center;"><input style="width: 30px; height: 30px; border: 1px dashed gray;" type="text"/></div> <div style="text-align: center;"><input style="width: 30px; height: 30px; border: 1px dashed gray;" type="text"/></div> <div style="text-align: center;"><input style="width: 30px; height: 30px; border: 1px dashed gray;" type="text"/></div> </div>	<p>៤ . គូររង្វង់ជុំវិញស្រះ (០)</p> <div style="display: grid; grid-template-columns: repeat(5, 1fr); gap: 20px;"> <!-- Row 1 --> <div style="text-align: center;"><input style="width: 30px; height: 30px; border: 1px dashed gray;" type="text"/></div> <div style="text-align: center;"><input style="width: 30px; height: 30px; border: 1px dashed gray;" type="text"/></div> <div style="text-align: center;"><input style="width: 30px; height: 30px; border: 1px dashed gray;" type="text"/></div> <div style="text-align: center;"><input style="width: 30px; height: 30px; border: 1px dashed gray;" type="text"/></div> <div style="text-align: center;"><input style="width: 30px; height: 30px; border: 1px dashed gray;" type="text"/></div> <!-- Row 2 --> <div style="text-align: center;"><input style="width: 30px; height: 30px; border: 1px dashed gray;" type="text"/></div> <div style="text-align: center;"><input style="width: 30px; height: 30px; border: 1px dashed gray;" type="text"/></div> <div style="text-align: center;"><input style="width: 30px; height: 30px; border: 1px dashed gray;" type="text"/></div> <div style="text-align: center;"><input style="width: 30px; height: 30px; border: 1px dashed gray;" type="text"/></div> <div style="text-align: center;"><input style="width: 30px; height: 30px; border: 1px dashed gray;" type="text"/></div> <!-- Row 3 --> <div style="text-align: center;"><input style="width: 30px; height: 30px; border: 1px dashed gray;" type="text"/></div> <div style="text-align: center;"><input style="width: 30px; height: 30px; border: 1px dashed gray;" type="text"/></div> <div style="text-align: center;"><input style="width: 30px; height: 30px; border: 1px dashed gray;" type="text"/></div> <div style="text-align: center;"><input style="width: 30px; height: 30px; border: 1px dashed gray;" type="text"/></div> <div style="text-align: center;"><input style="width: 30px; height: 30px; border: 1px dashed gray;" type="text"/></div> <!-- Row 4 --> <div style="text-align: center;"><input style="width: 30px; height: 30px; border: 1px dashed gray;" type="text"/></div> <div style="text-align: center;"><input style="width: 30px; height: 30px; border: 1px dashed gray;" type="text"/></div> <div style="text-align: center;"><input style="width: 30px; height: 30px; border: 1px dashed gray;" type="text"/></div> <div style="text-align: center;"><input style="width: 30px; height: 30px; border: 1px dashed gray;" type="text"/></div> <div style="text-align: center;"><input style="width: 30px; height: 30px; border: 1px dashed gray;" type="text"/></div> </div>



ល្បែងគូសតាមស្នាមចុច(ស្រ: (□) និង ដាត់ពណ័រូបភាព



ស្កែន QR Code

សាលាមត្តេយ្យ ..... ថ្នាក់កម្រិត .....

ឈ្មោះ: ..... កាលបរិច្ឆេទ .....

ដំ



# ស្ថានស្រី (ប្រាំ) និងដាត់ពណ៌



ស្កេន QR Code

សាលាមត្តេយ្យ ..... ថ្នាក់កម្រិត .....

ឈ្មោះ ..... កាលបរិច្ឆេទ .....

<p>១ .ដាត់ពណ៌ស្រី: (ប្រាំ)</p>	<p>២ .គូររង្វង់ស្រី: (ប្រាំ) និងដាត់ពណ៌រូបភាព</p>	
	<p>ដាំ</p>	<p>○ □</p> <p>□ ាំ</p> <p>□ ៖</p>
<p>៣ .គូសតាមស្នាមចុចស្រី: (ប្រាំ)</p>	<p>៤ .គូររង្វង់ជុំវិញស្រី: (ប្រាំ)</p>	

ល្បែងគូសតាមស្នាមចុច(ស្រះ (□៖) និង ផាត់ពណ័រូបភាព



ស្កេន QR Code

សាលាមត្តេយ្យ ..... ថ្នាក់កម្រិត .....

ឈ្មោះ : ..... កាលបរិច្ឆេទ .....

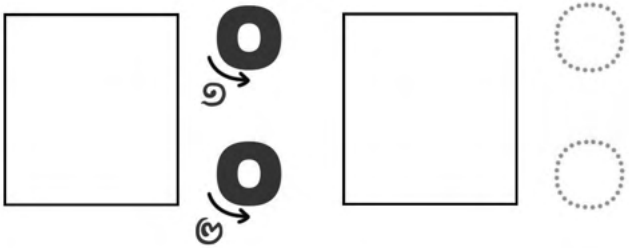
ខ៖ក៏



ស្ថានស្រី (០៖) និងជាតំណាង



ស្កេន QR Code

សាលាមត្តេយ្យ ..... ថ្នាក់កម្រិត .....

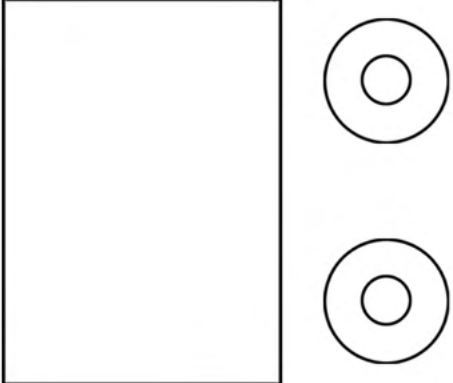
ឈ្មោះ ..... កាលបរិច្ឆេទ .....

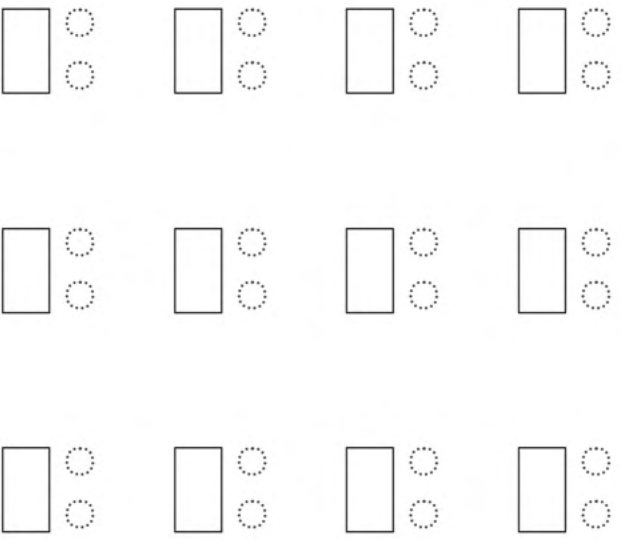
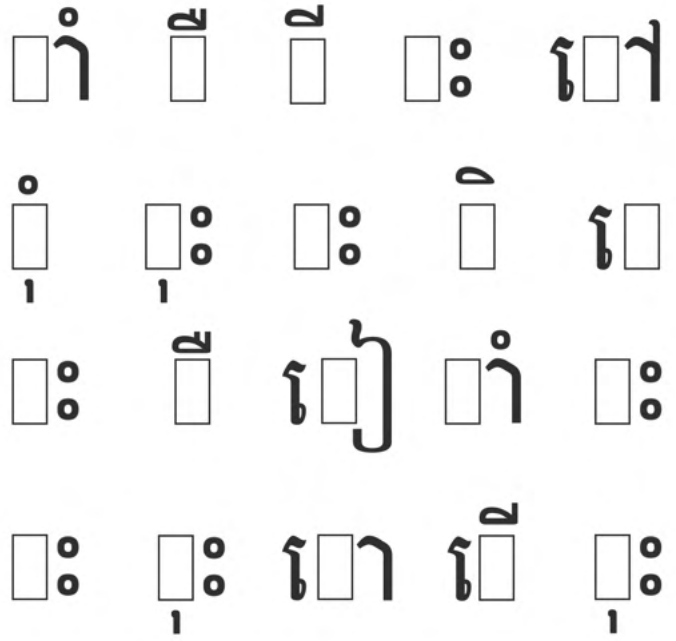
<p>១ . ជាតំណាងស្រី: (០៖)</p>	<p>២ . គូររង្វង់ស្រី: (០៖) និងជាតំណាងរូបភាព</p>	
	 <p>ខ៖កី</p>	<p>កាំ</p> <p>០៖</p> <p>០៖</p> <p>០៖</p> <p>០៖</p>
<p>៣ . គូសតាមស្នាមចុចស្រី: (០៖)</p>	<p>៤ . គូររង្វង់ជុំវិញស្រី: (០៖)</p>	
		



# ល្បែងគូសភ្ជាប់ (ស្រែ: ទៅនឹងរូបភាព និងថាវាណា)



ស្កេន QR Code

សាលាមត្តេយ្យ ..... ថ្នាក់កម្រិត .....

ឈ្មោះ: ..... កាលបរិច្ឆេទ .....

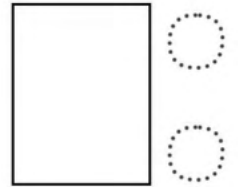
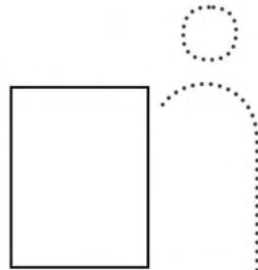
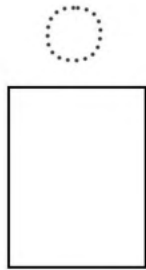

ដាំ



ខ្វះកី



ខ្នុរ



យុំ

រកចំណុចខុសគ្នា ចំនួនដប់រវាងរូបទាំងពីរ  
និងគូររង្វង់លើរូបភាពនោះ



ស្កេន QR Code

សាលាមត្តេយ្យ ..... ថ្នាក់កម្រិត .....

ឈ្មោះ : ..... កាលបរិច្ឆេទ .....

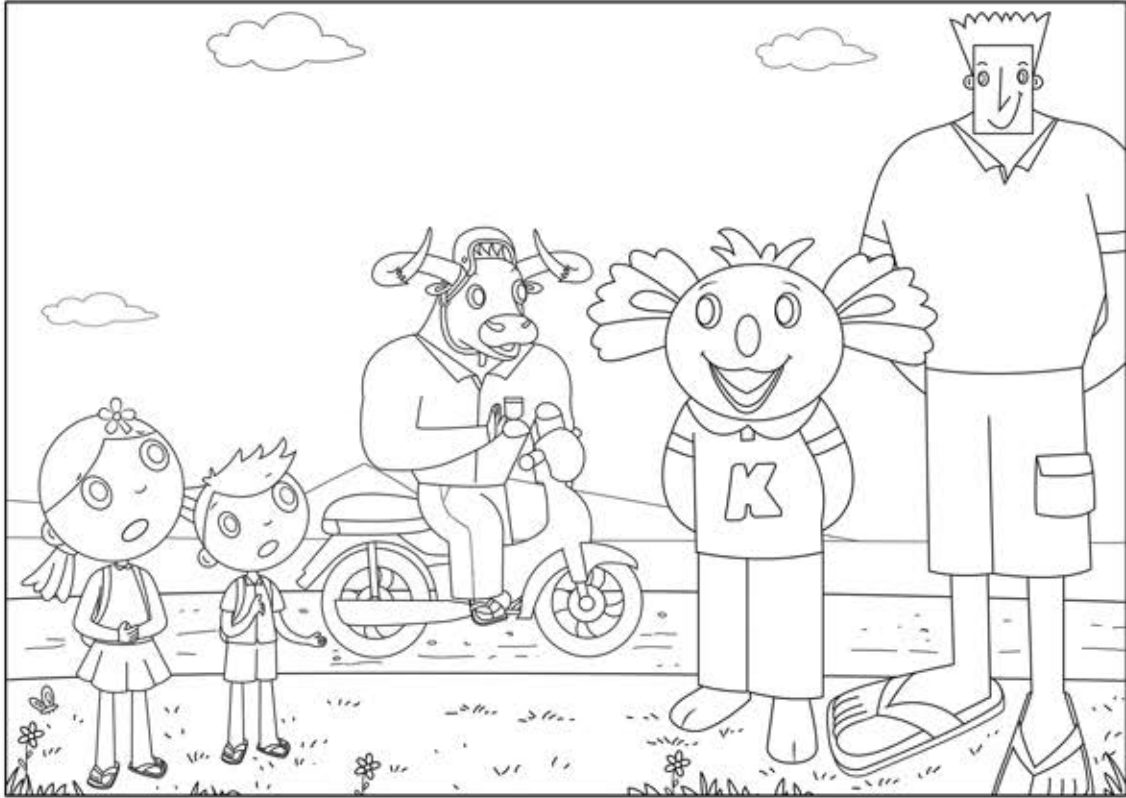

# ល្បែងគូសតាមស្នាមចុច(ស្រី៖ (្ក្ន) និង ផាត់ពណ៌រូបភាព



ស្កេន QR Code

សាលាមត្តេយ្យ ..... ថ្នាក់កម្រិត .....

ឈ្មោះ ..... កាលបរិច្ឆេទ .....

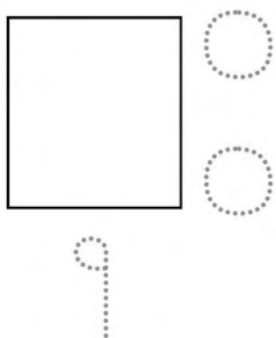
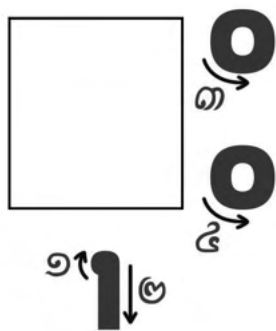
១៖



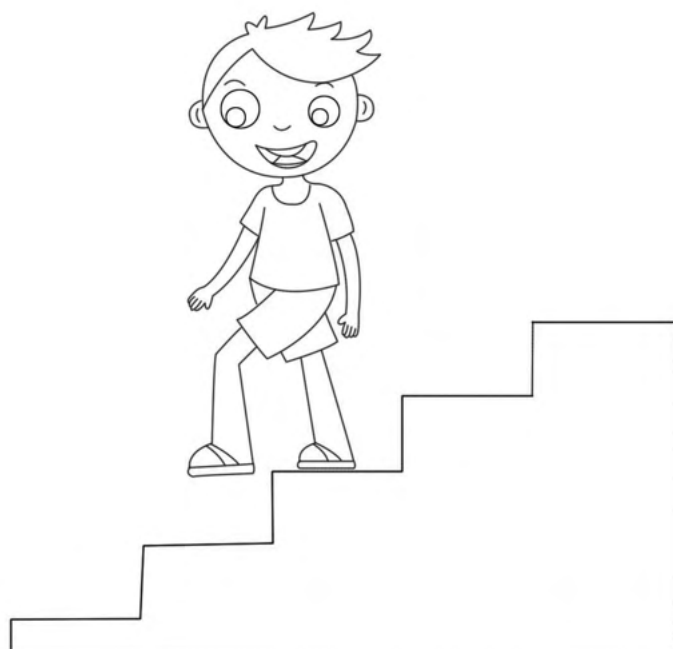

ស្ថាប័ន (ស្រះ, ៖) និង ជាត់ពណ៌



ស្កេន QR Code

សាលាមត្តេយ្យ ..... ថ្នាក់កម្រិត .....

ឈ្មោះ ..... កាលបរិច្ឆេទ .....

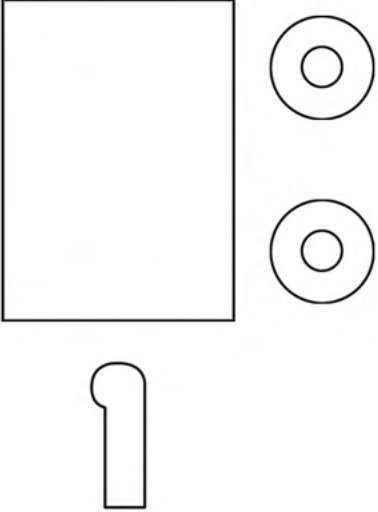
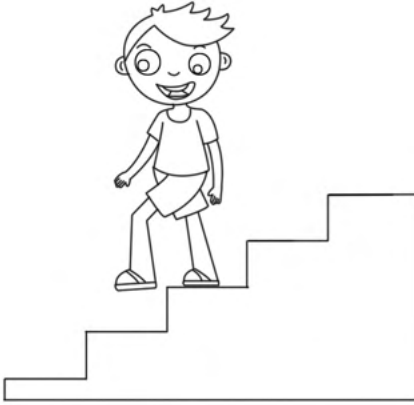
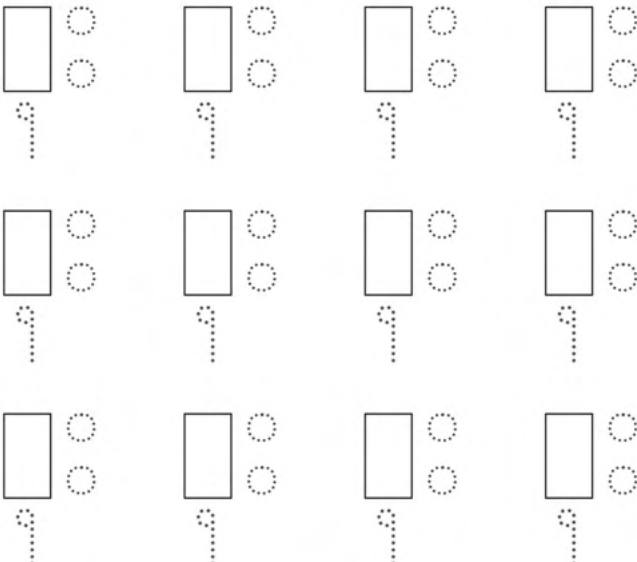
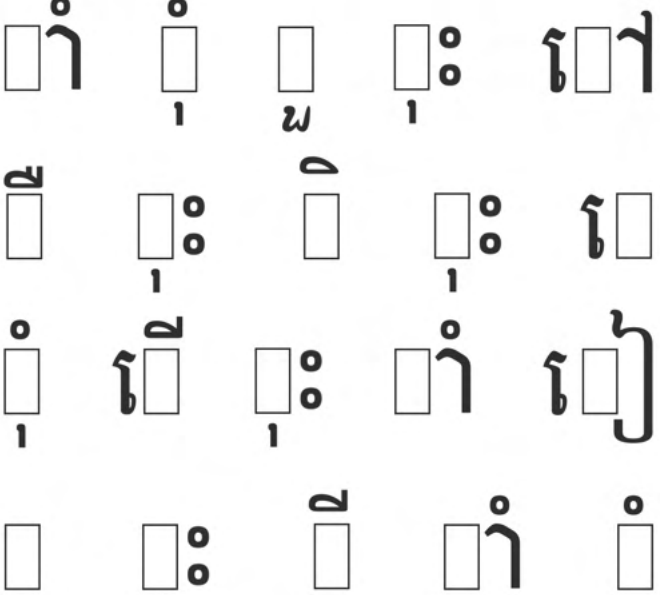
<p>១ . ជាត់ពណ៌ស្រះ (០៖)</p>	<p>២ . គូររង្វង់ស្រះ (០៖) និង ជាត់ពណ៌រូបភាព</p>	
	 <p>ចុះ</p>	<p>០</p> <p>១</p> <p>២</p>
<p>៣ . គូសតាមស្នាមចុចស្រះ (០៖)</p>	<p>៤ . គូររង្វង់ជុំវិញស្រះ (០៖)</p>	
		

ល្បែងគូសតាមស្នាមចុច(ស្រះ (៤០៖) និង ផាត់ពណ៌រូបភាព



ស្កេន QR Code

សាលាមត្តេយ្យ ..... ថ្នាក់កម្រិត .....

ឈ្មោះ ..... កាលបរិច្ឆេទ .....

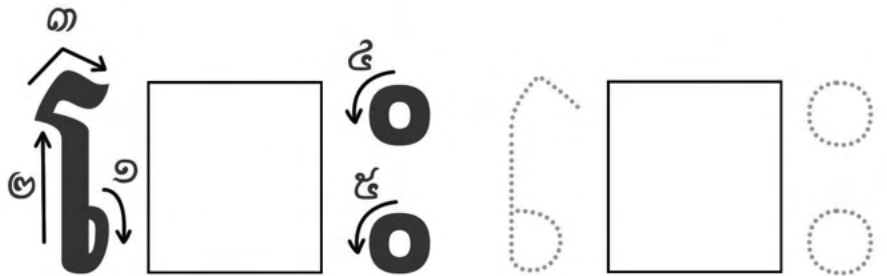
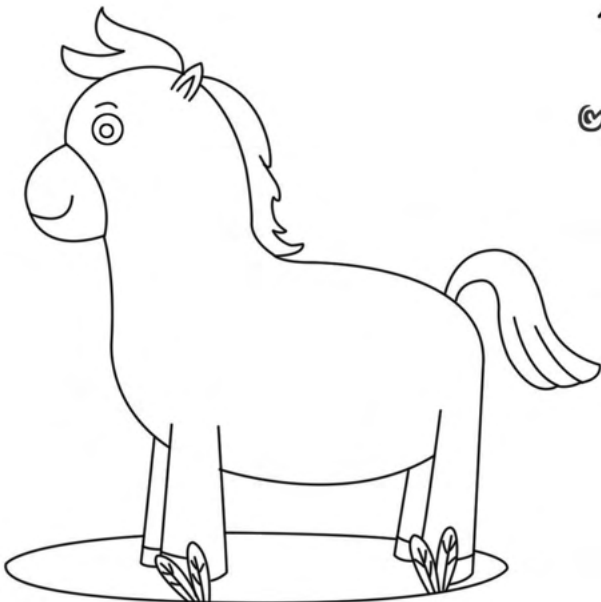
ស្រះ

# ស្ថាប័ន (ស្រះ) និង ដាត់ពណ៌



ស្កេន QR Code

សាលាមត្តេយ្យ ..... ថ្នាក់កម្រិត .....

ឈ្មោះ ..... កាលបរិច្ឆេទ .....

<p>១ .ដាត់ពណ៌ស្រះ (៤០)</p>	<p>២ .គូររង្វង់ស្រះ (៤០) និងដាត់ពណ៌រូបភាព</p>	
	<p>សេះ</p>	<p>០</p> <p>៤០៖</p> <p>៤០៖</p>
<p>៣ .គូសតាមស្នាមចុចស្រះ (៤០)</p>	<p>៤ .គូររង្វង់ជុំវិញស្រះ (៤០)</p>	

ល្បែងគូសតាមស្នាមចុច(ស្រះ (្កោះ) និង ផាត់ពណ៌រូបភាព



ស្កេន QR Code

សាលាមត្តេយ្យ ..... ផ្នែកកម្រិត .....

ឈ្មោះ ..... កាលបរិច្ឆេទ .....

ហោះ :

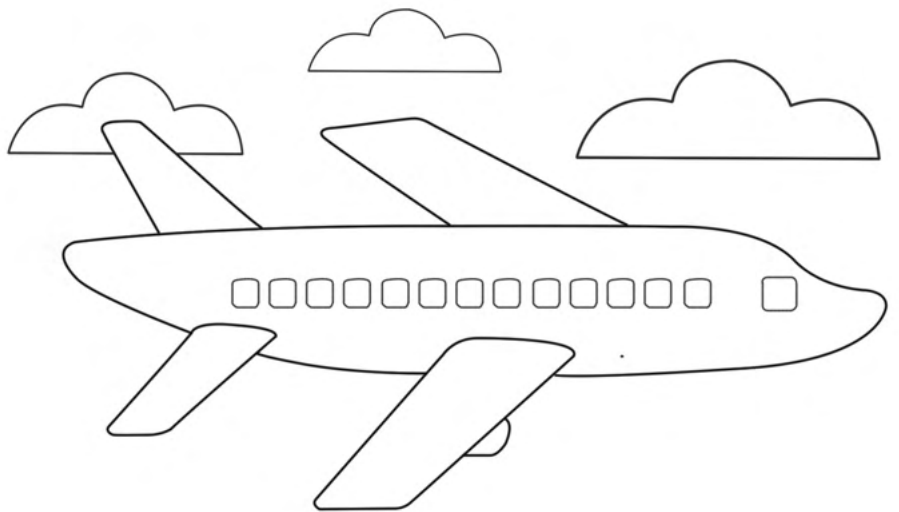

# ស្នាដៃស្រ្តី (១០១) និងដាត់ពណ៌



ស្កេន QR Code

សាលាមត្តេយ្យ ..... ថ្នាក់កម្រិត .....

ឈ្មោះ ..... កាលបរិច្ឆេទ .....

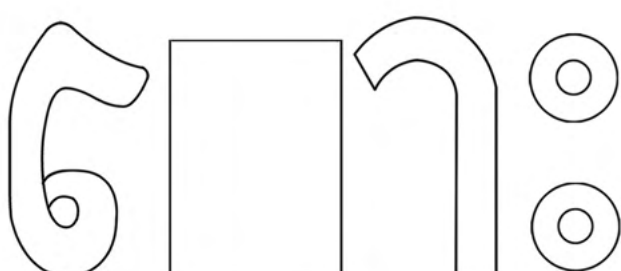
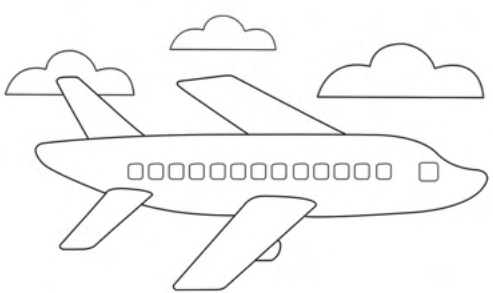
<p>១ .ដាត់ពណ៌ស្រ្តី: (១០១)</p>	<p>២ .គូររង្វង់ស្រ្តី: (១០១) និងដាត់ពណ៌រូបភាព</p>	
	 <p>ហោះ :</p>	<p>ស្រ្តី</p> <p>ស្រ្តី</p> <p>ស្រ្តី</p>
<p>៣ .គូសតាមស្នាមចុចស្រ្តី: (១០១)</p>	<p>៤ .គូររង្វង់ជុំវិញស្រ្តី: (១០១)</p>	
<p>ស្រ្តី ស្រ្តី ស្រ្តី</p> <p>ស្រ្តី ស្រ្តី ស្រ្តី</p> <p>ស្រ្តី ស្រ្តី ស្រ្តី</p>	<p>ស្រ្តី ស្រ្តី ស្រ្តី ស្រ្តី</p> <p>ស្រ្តី ស្រ្តី ស្រ្តី ស្រ្តី</p> <p>ស្រ្តី ស្រ្តី ស្រ្តី ស្រ្តី</p> <p>ស្រ្តី ស្រ្តី ស្រ្តី ស្រ្តី</p>	

# ល្បែងគូសភ្ជាប់(ស្រែ:ទៅនឹងរូបភាព និងផ្ទាំងពណ៌)



ស្កេន QR Code

សាលាមត្តេយ្យ ..... ថ្នាក់កម្រិត .....

ឈ្មោះ: ..... កាលបរិច្ឆេទ .....

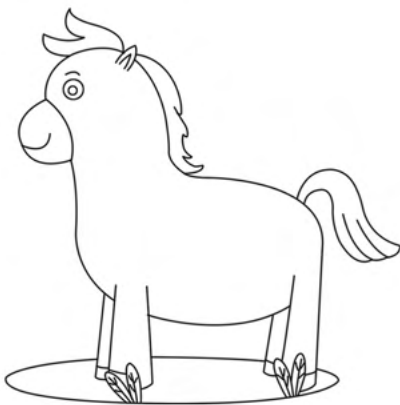
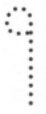
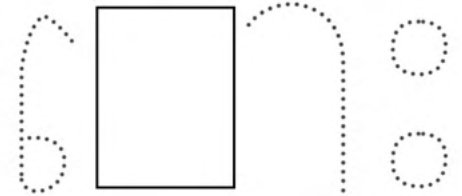
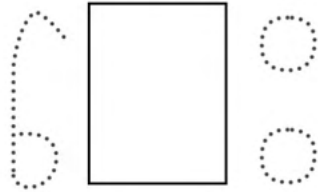
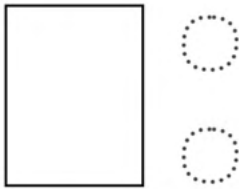

សេះ

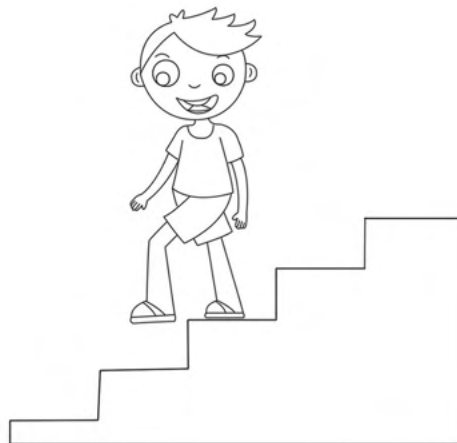

ថ្មី

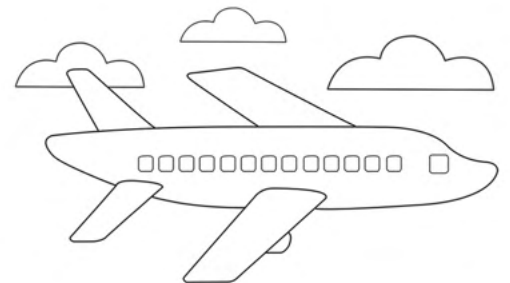

ហោះ

# ល្បែងស្វែងរករូបភាព



ស្កេន QR Code

សាលាមត្តេយ្យ ..... ថ្នាក់កម្រិត .....

ឈ្មោះ : ..... កាលបរិច្ឆេទ .....

## ដាត់ពណ៌ ឬគូររូបរូបភាពដែលមិនដូចគ្នា

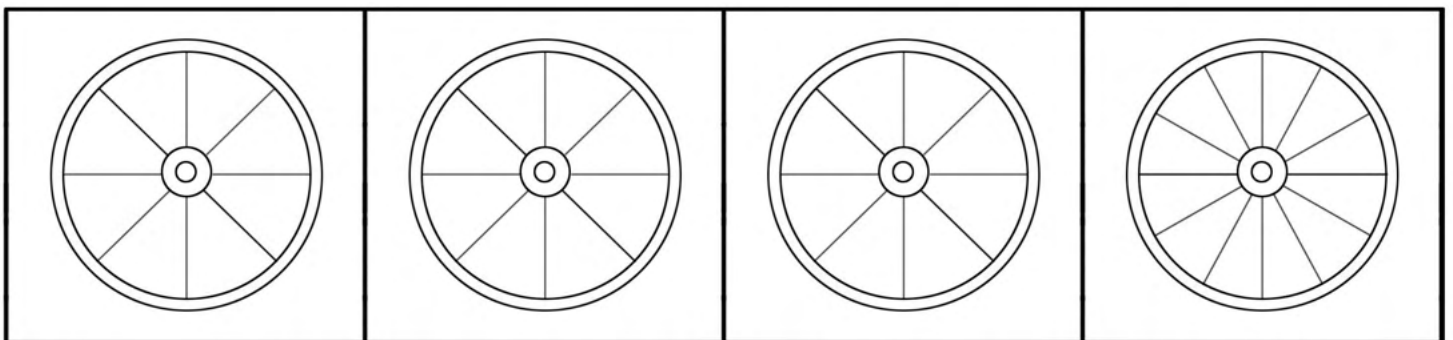
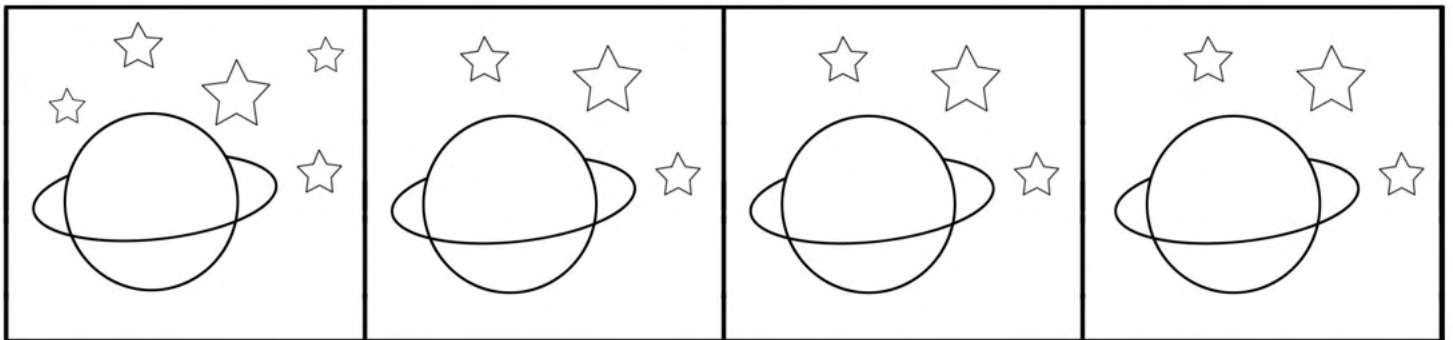
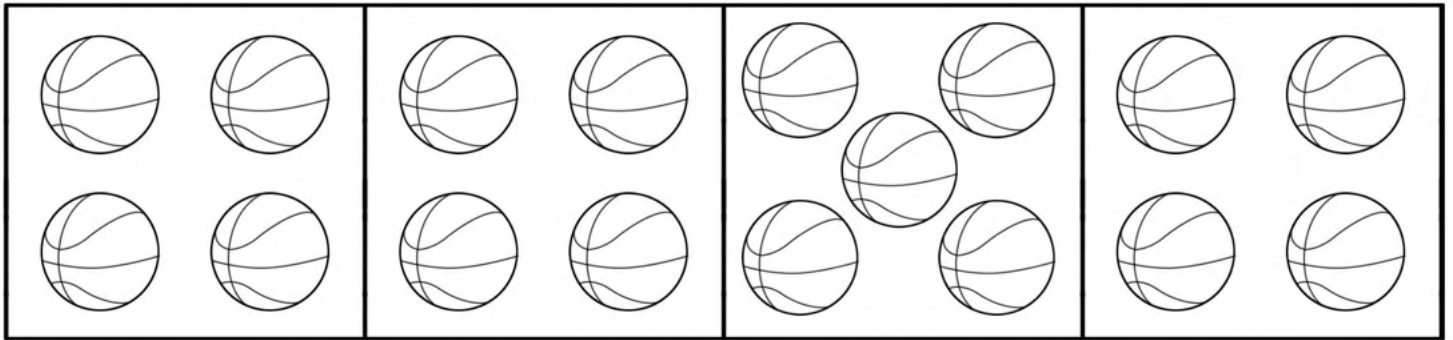
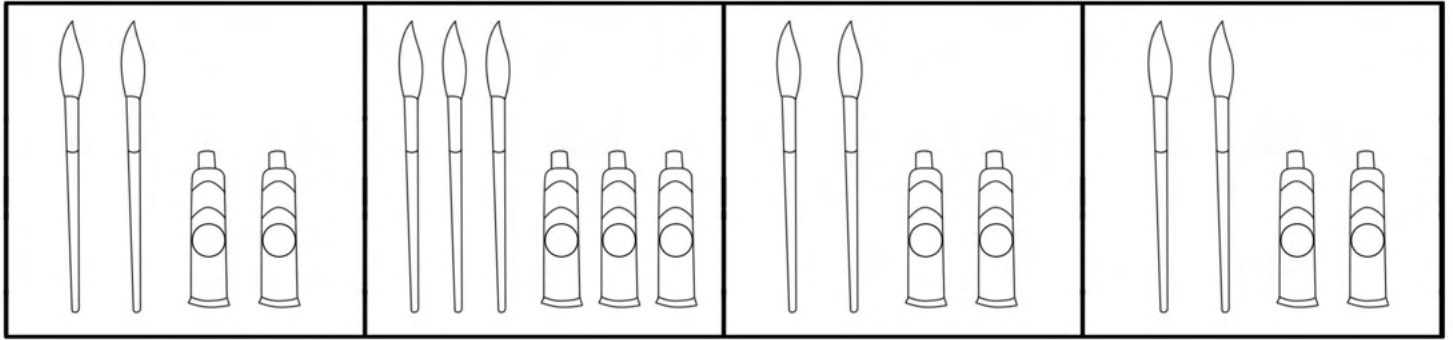

# ស្បែកគូរបំពេញទឹកមុខ



សាលាមន្តេយ្យ..... ថ្នាក់កម្រិត.....

ឈ្មោះ..... កាលបរិច្ឆេទ.....

ស្កេន QR Code

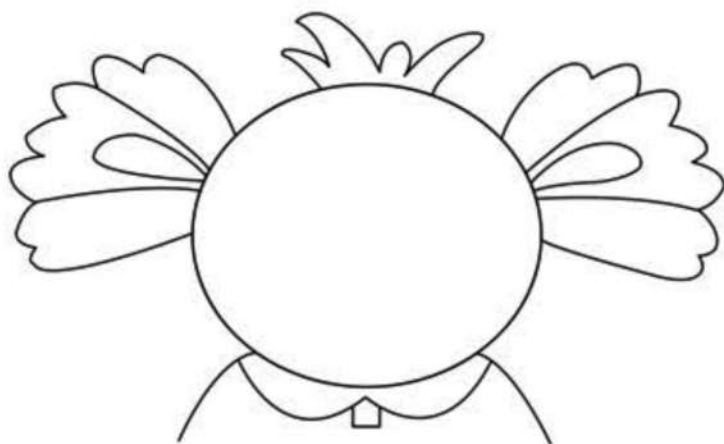
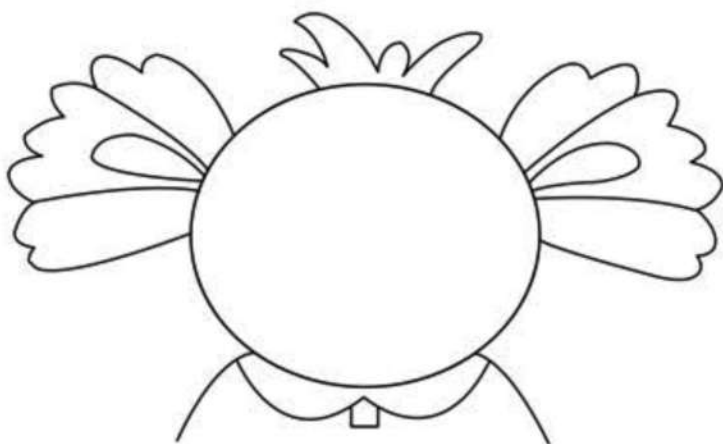

១. រីករាយ



២. កើតទុក្ខ

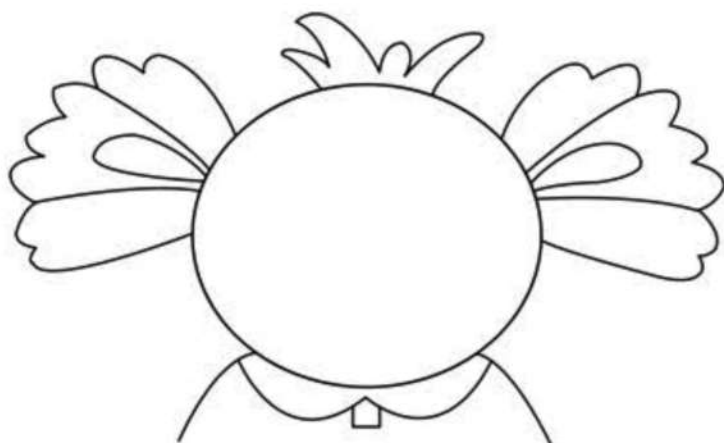
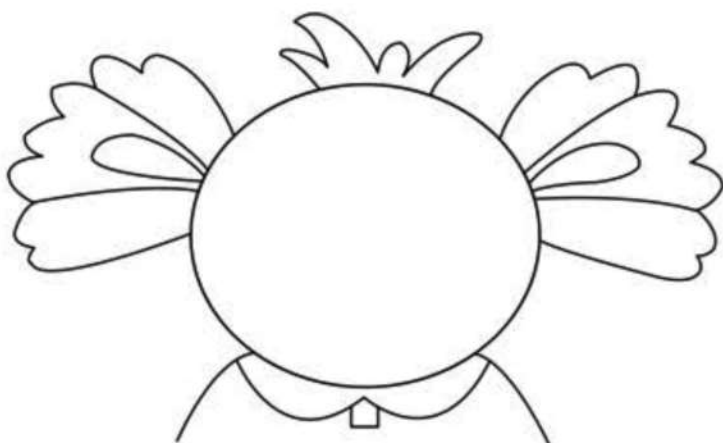
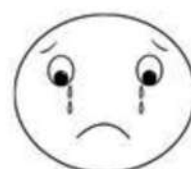

៣. ខឹង



៤. ដង្ហើម





# គួររចនាម៉ូដក្រមាដោយសេរី



ស្កេន QR Code

សាលាមត្តេយ្យ ..... ថ្នាក់កម្រិត .....

ឈ្មោះ : ..... កាលបរិច្ឆេទ .....

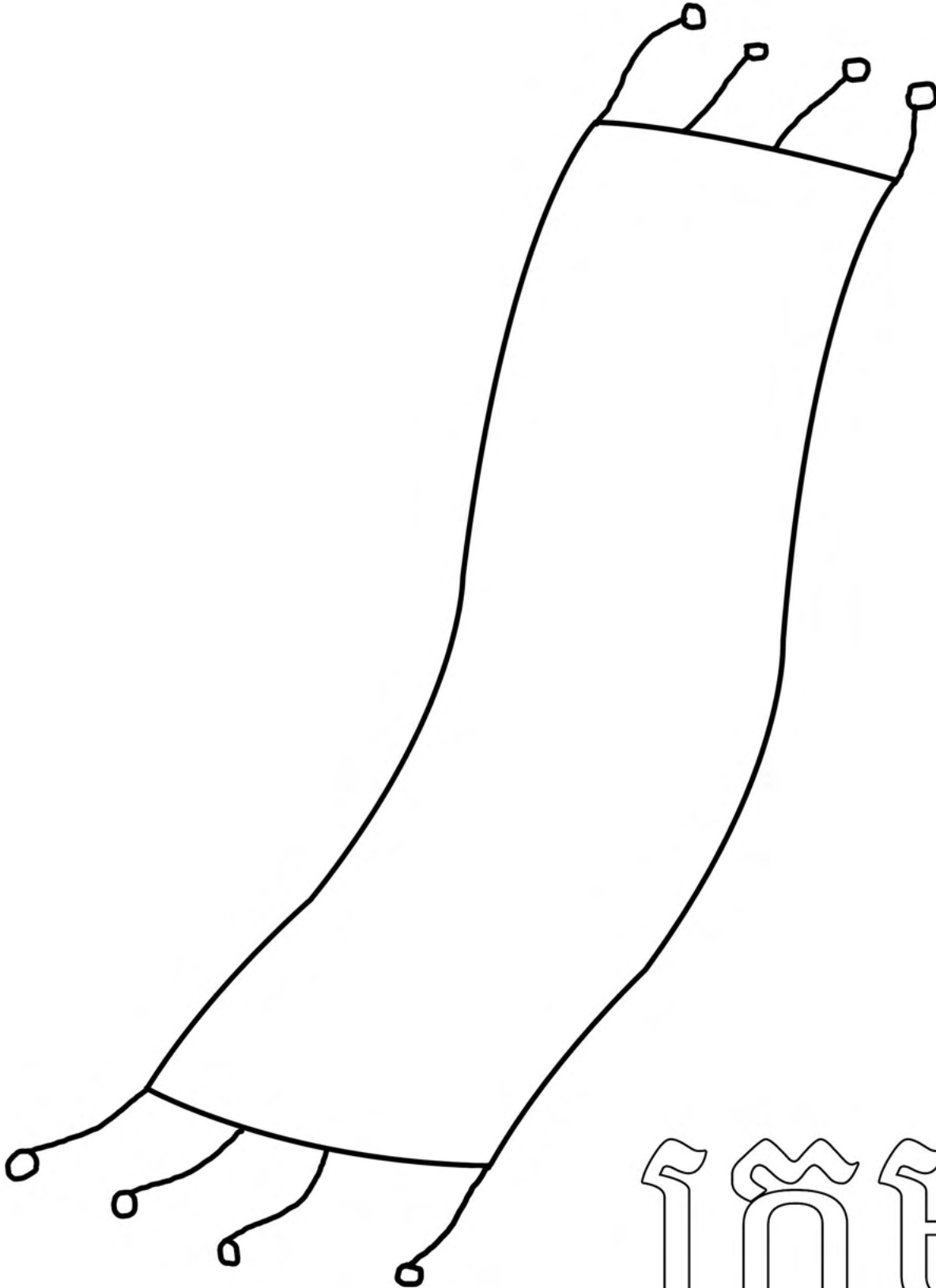

# ក្រមា

# ស្វែងរកវិញ្ញាណមួយណា?



ស្កេន QR Code

សាលាមត្តេយ្យ ..... ថ្នាក់កម្រិត .....

ឈ្មោះ : ..... កាលបរិច្ឆេទ .....

## ផាត់ពណ៌រូបភាពឱ្យត្រូវតាមវិញ្ញាណទាំងប្រាំ

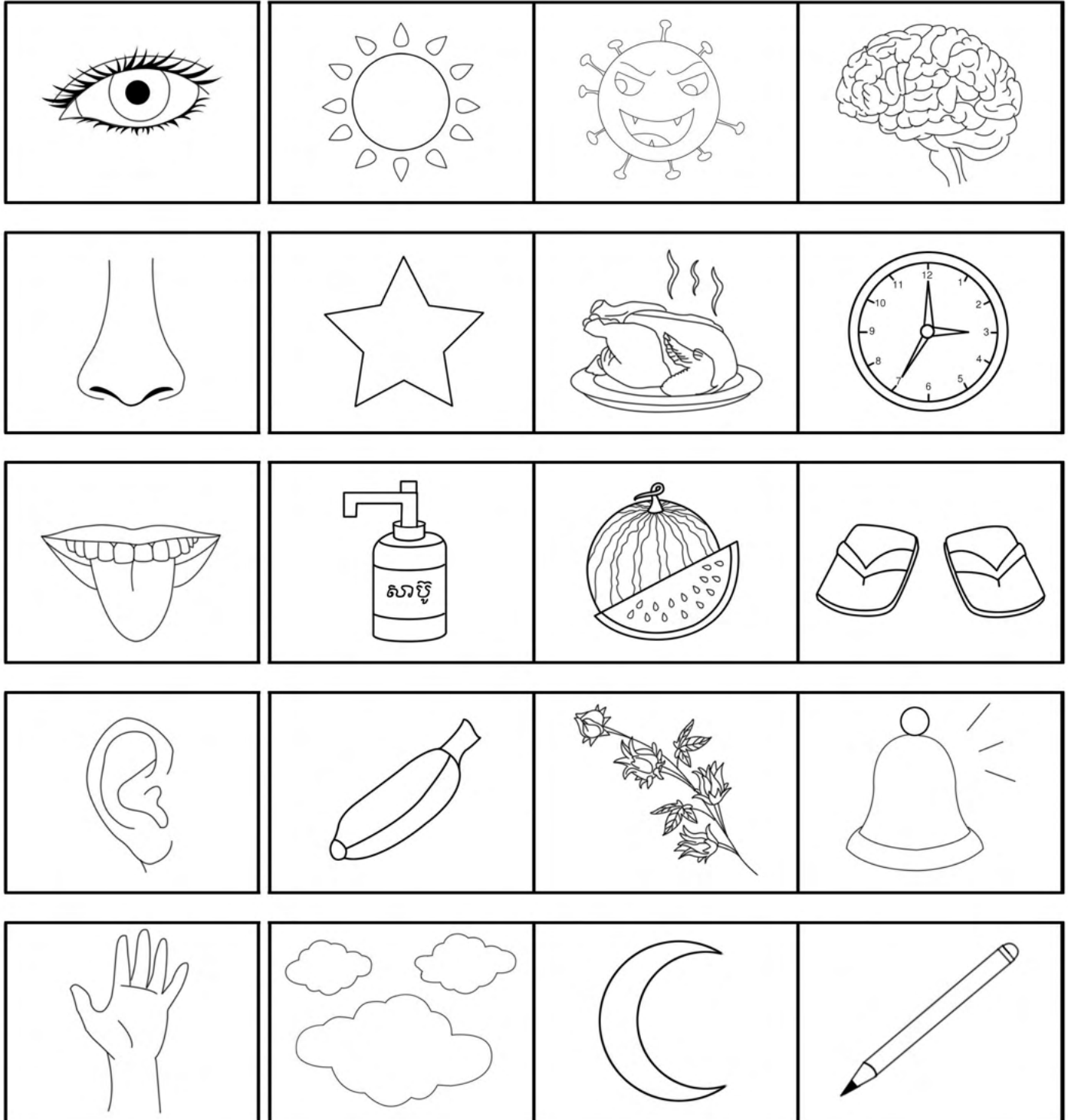

រកចំណុចខុសគ្នាចំនួនប្រាំពីរ  
រវាងរូបទាំងពីរ និងគូររង្វង់លើរូបភាពនោះ



ស្កេន QR Code

សាលាមត្តេយ្យ ..... ថ្នាក់កម្រិត .....

ឈ្មោះ : ..... កាលបរិច្ឆេទ .....

