

# ល្បែងគូសតាមស្នាមចុច(ស្រះ (១១) និង ផាត់ពណ័រូបភាព



ស្កេន QR Code

សាលាមត្តេយ្យ ..... ផ្នែកកម្រិត .....

ឈ្មោះ: ..... កាលបរិច្ឆេទ .....

ក

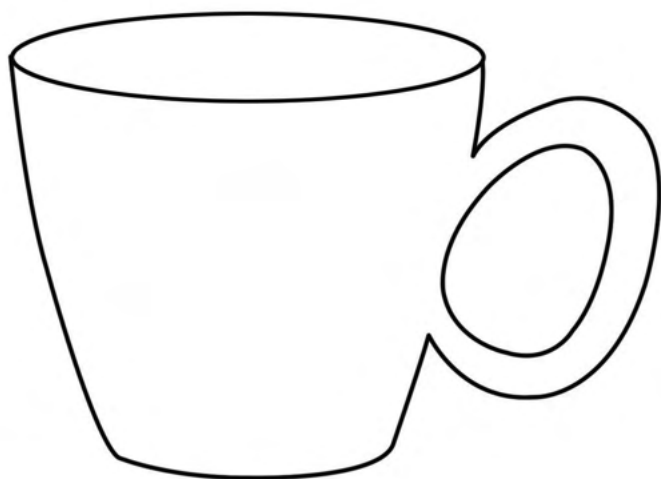













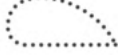

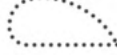

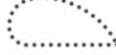

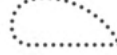

ល្បែងគូសតាមស្នាមចុច(ស្រី៖ (០) និង  
 ផាត់ពណ៌រូបភាព



ស្កេន QR Code

សាលាមត្តេយ្យ ..... ផ្នែកកម្រិត .....

ឈ្មោះ : ..... កាលបរិច្ឆេទ .....

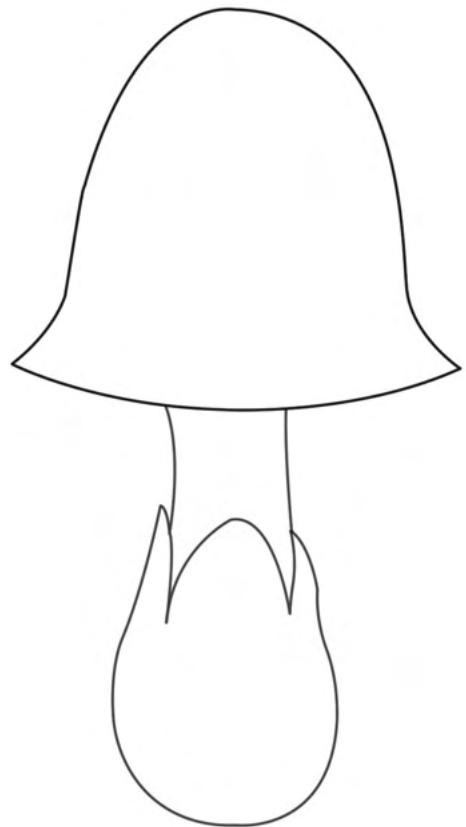

ផ្សិត













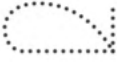



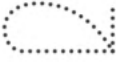

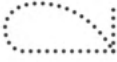

ល្បែងគូសតាមស្នាមចុច(ស្រ: (០)) និង  
 ផាត់ពណ័រូបភាព



ស្កែន QR Code

សាលាមត្តេយ្យ ..... ផ្នែកកម្រិត .....

ឈ្មោះ: ..... កាលបរិច្ឆេទ .....



ស៊ី

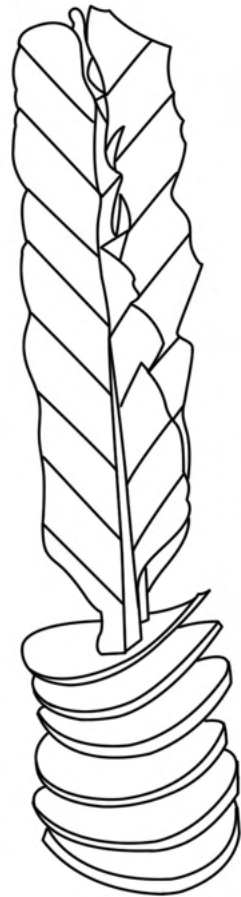

ល្បែងគូសតាមស្នាមចុច(ស្រ: (ី) និង  
 ផាត់ពណ័រូបភាព



ស្កេន QR Code

សាលាមត្តេយ្យ ..... ផ្នែកកម្រិត .....

ឈ្មោះ: ..... កាលបរិច្ឆេទ .....



ឱ ឱ



ល្បែងគូសតាមស្នាមចុច(ស្រះ (្ក) និង ផាត់ពណ៌រូបភាព



ស្កេន QR Code

សាលាមត្តេយ្យ ..... ថ្នាក់កម្រិត .....

ឈ្មោះ: ..... កាលបរិច្ឆេទ .....

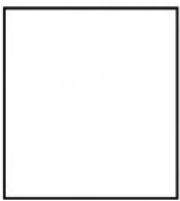
ឃ



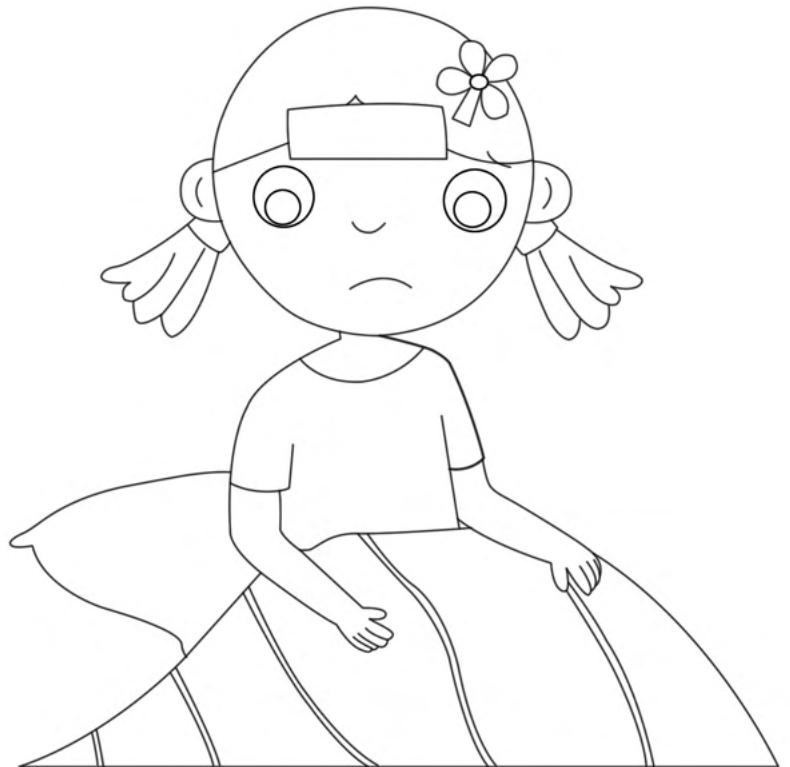



# ល្បែងគូសតាមស្នាមចុច(ស្រះ (្ក)និង ផាត់ពណ៌រូបភាព

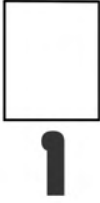
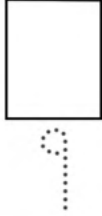
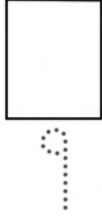
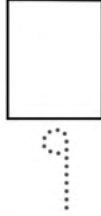

ស្កេន QR Code

សាលាមត្តេយ្យ ..... ផ្នែកកម្រិត .....

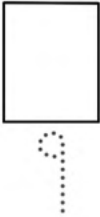
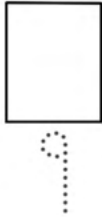
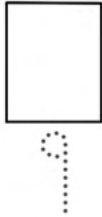
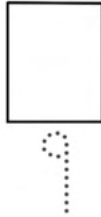
ឈ្មោះ: ..... កាលបរិច្ឆេទ .....



ត្រី



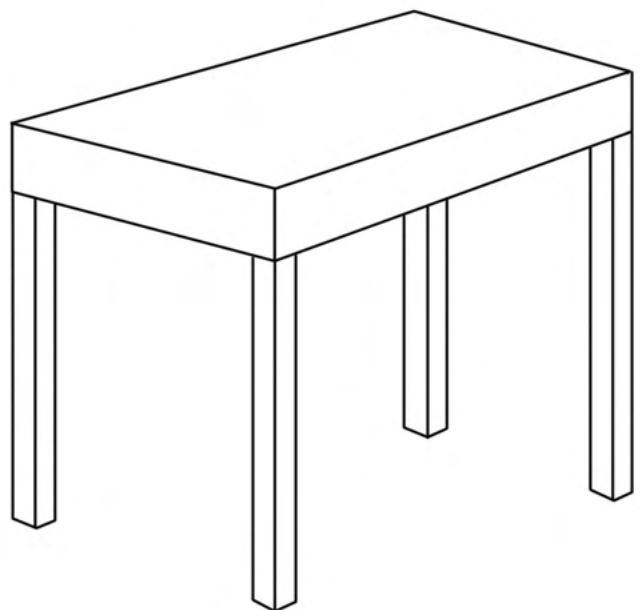

















# ល្បែងគូសតាមស្នាមចុច(ស្រះ (្រ) និង ផាត់ពណ័រូបភាព



ស្កេន QR Code

សាលាមត្តេយ្យ ..... ថ្នាក់កម្រិត .....

ឈ្មោះ: ..... កាលបរិច្ឆេទ .....

 <b>ប</b>	 	 	 	 
 	 	 	 	 

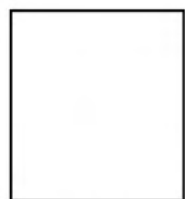

ប្រ

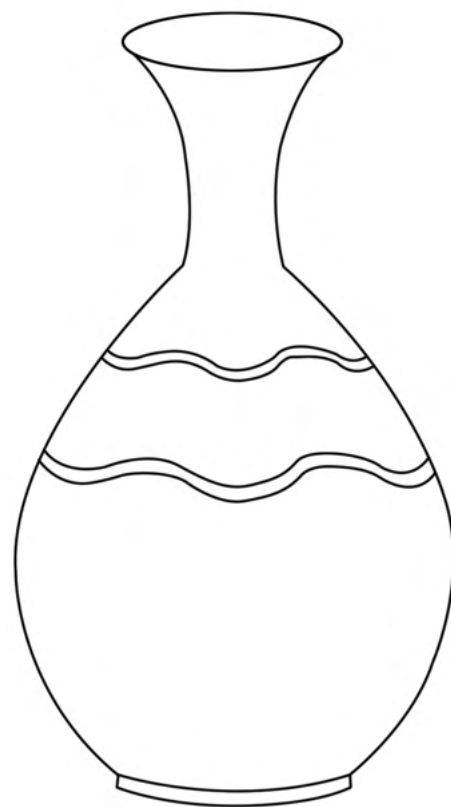





ល្បែងគូសតាមស្នាមចុច(ស្រះ (្ក)និង  
 ផាត់ពណ៌រូបភាព

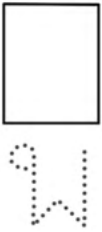
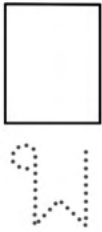

ស្កេន QR Code

សាលាមត្តេយ្យ ..... ថ្នាក់កម្រិត .....

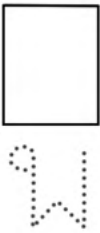
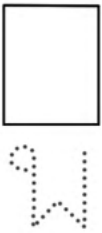
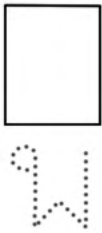
ឈ្មោះ: ..... កាលបរិច្ឆេទ .....

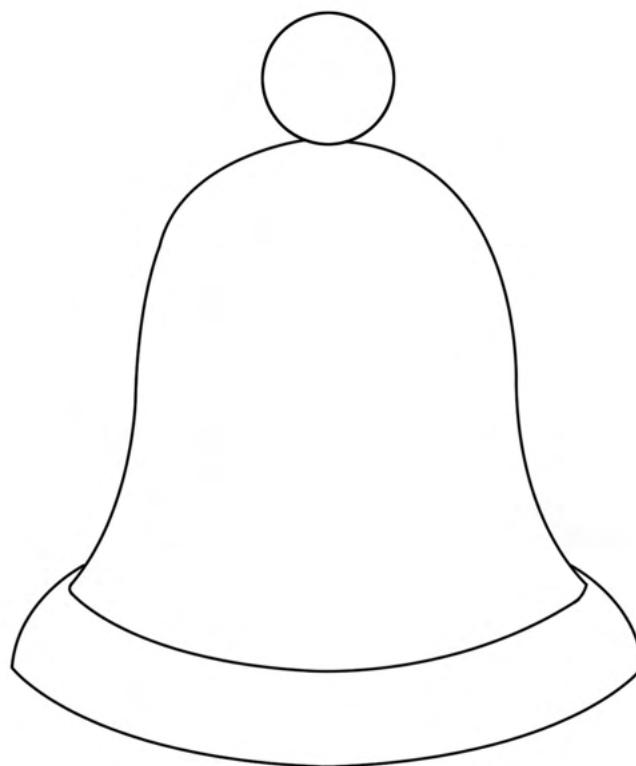
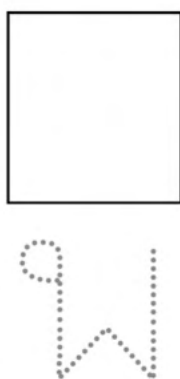
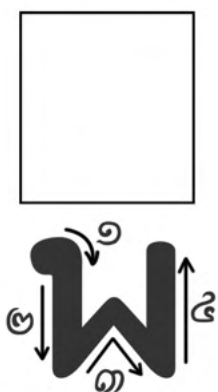

ជូង



ល្បែងគូសតាមស្នាមចុច(ស្រ: (រឺ)) និង  
 ផាត់ពណ័រូបភាព



ស្កែន QR Code

សាលាមត្តេយ្យ ..... ថ្នាក់កម្រិត .....

ឈ្មោះ: ..... កាលបរិច្ឆេទ .....

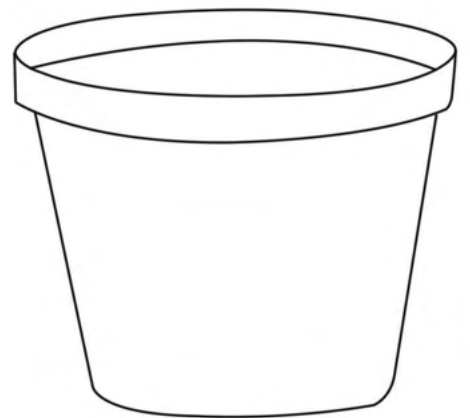
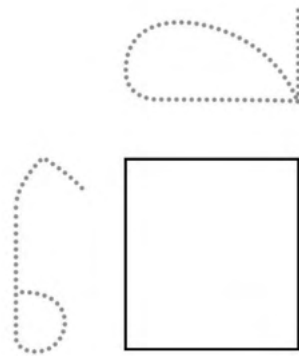
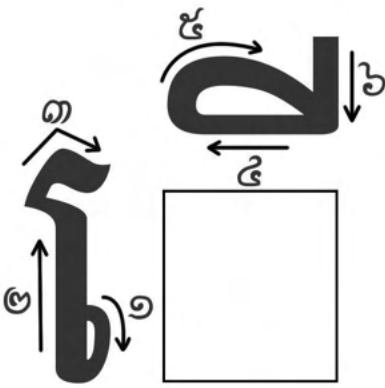
ដើម

ល្បែងគូសតាមស្នាមចុច(ស្រ: (ឆៀ)) និង  
 ដាត់ពណ៌រូបភាព



ស្ត្រីន QR Code

សាលាមត្តេយ្យ ..... ផ្នែកកម្រិត .....

ឈ្មោះ: ..... កាលបរិច្ឆេទ .....

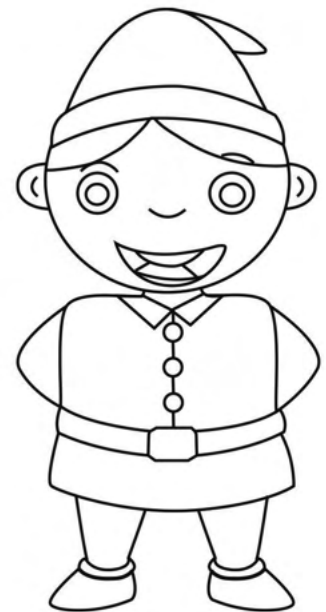
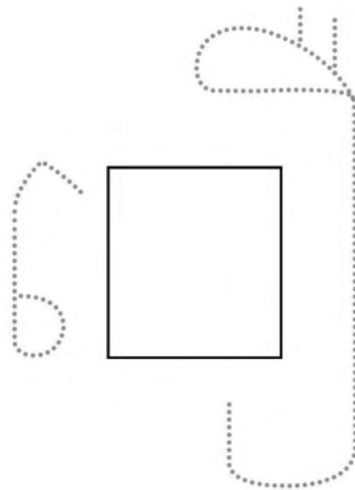
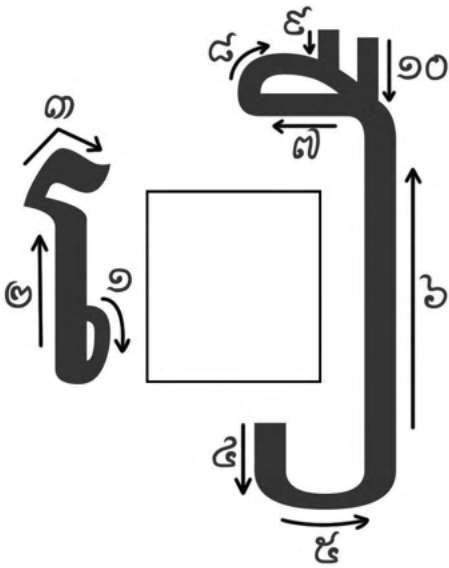
ឆៀ

ល្បែងគូសតាមស្នាមចុច(ស្រះ (ទៀប) និង ដាត់ពណ័រូបភាព



ស្កេន QR Code

សាលាមត្តេយ្យ ..... ថ្នាក់កម្រិត .....

ឈ្មោះ: ..... កាលបរិច្ឆេទ .....

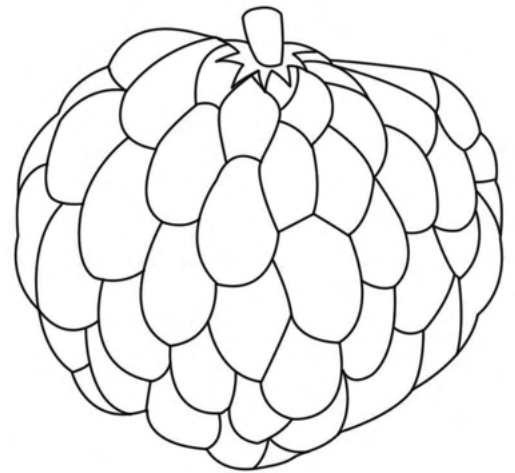
ទៀប

ល្បែងគូសតាមស្នាមចុច(ស្រះ (៤០) និង  
 ផាត់ពណ័រូបភាព



ស្កេន QR Code

សាលាមត្តេយ្យ ..... ផ្នែកកម្រិត .....

ឈ្មោះ: ..... កាលបរិច្ឆេទ .....

<input type="checkbox"/>	<input type="checkbox"/>	<input type="checkbox"/>	<input type="checkbox"/>	<input type="checkbox"/>
<input type="checkbox"/>	<input type="checkbox"/>	<input type="checkbox"/>	<input type="checkbox"/>	<input type="checkbox"/>

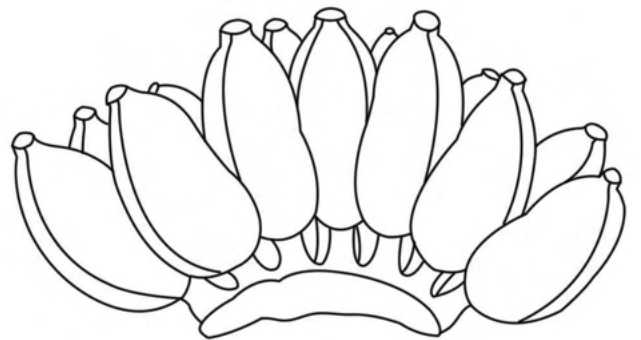

ថែកី



ល្បែងគូសតាមស្នាមចុច(ស្រ: (រំ) និង  
 ផាត់ពណ័រូបភាព



ស្កែន QR Code

សាលាមត្តេយ្យ ..... ថ្នាក់កម្រិត .....

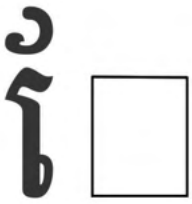
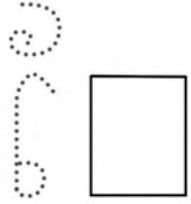
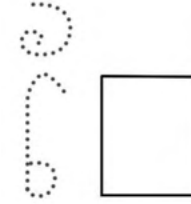
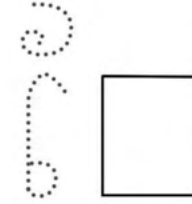
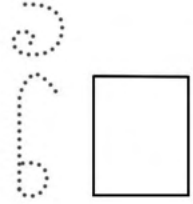
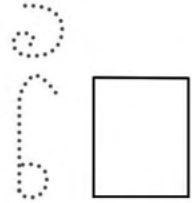
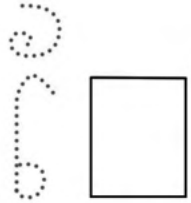
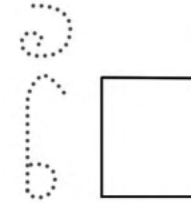
ឈ្មោះ: ..... កាលបរិច្ឆេទ .....

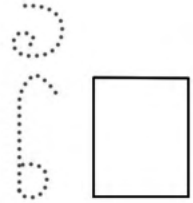
 <input type="checkbox"/>	 <input type="checkbox"/>	 <input type="checkbox"/>	 <input type="checkbox"/>	 <input type="checkbox"/>
 <input type="checkbox"/>	 <input type="checkbox"/>	 <input type="checkbox"/>	 <input type="checkbox"/>	 <input type="checkbox"/>

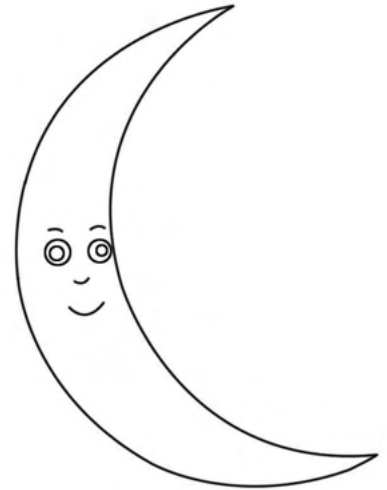
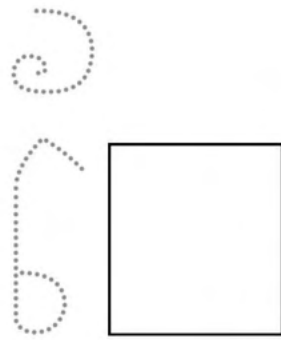
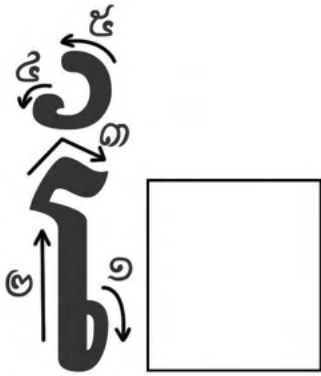

រំ

ល្បែងគូសតាមស្នាមចុច(ស្រ: ៃ) និង  
 ផាត់ពណ័រូបភាព



ស្កែន QR Code

សាលាមត្តេយ្យ ..... ផ្នែកកម្រិត .....

ឈ្មោះ: ..... កាលបរិច្ឆេទ .....

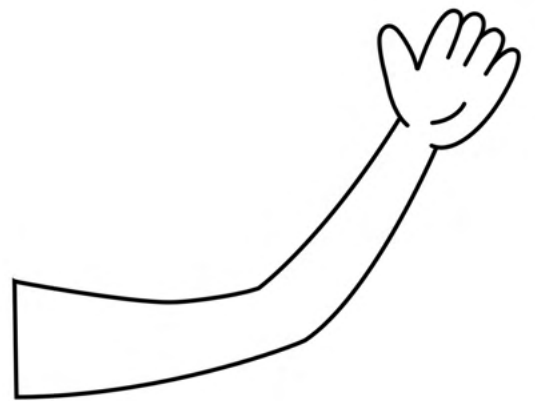
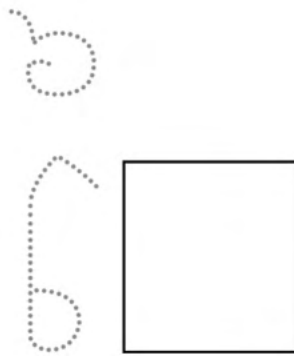
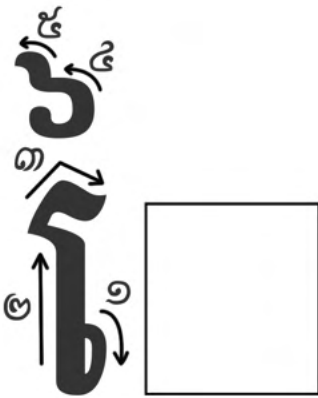
ដៃ

ល្បែងគូសតាមស្នាមចុច(ស្រះ (១០៦) និង ផាត់ពណ័រូបភាព



ស្កែន QR Code

សាលាមត្តេយ្យ ..... ថ្នាក់កម្រិត .....

ឈ្មោះ: ..... កាលបរិច្ឆេទ .....

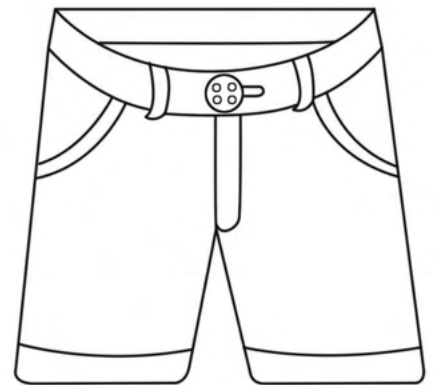
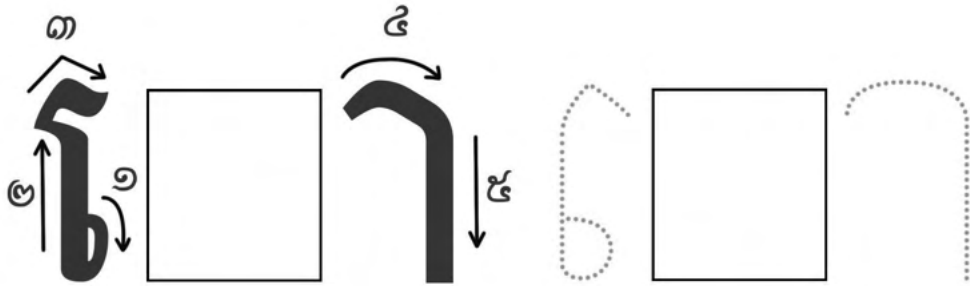
ខោ

ល្បែងគូសតាមស្នាមចុច(ស្រះ (១០៧) និង  
 ផាត់ពណ័រូបភាព



ស្កេន QR Code

សាលាមត្តេយ្យ ..... ថ្នាក់កម្រិត .....

ឈ្មោះ: ..... កាលបរិច្ឆេទ .....

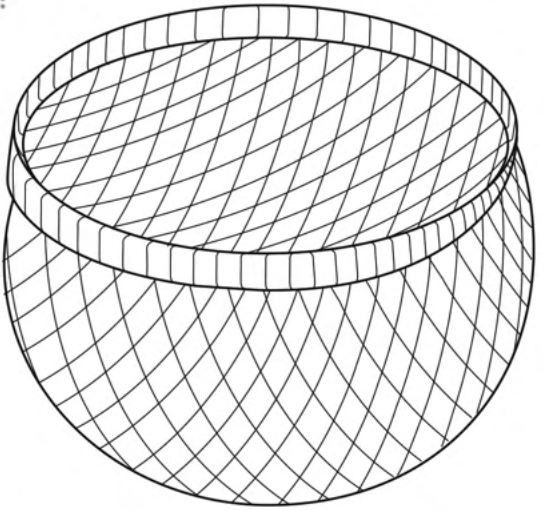
តោ



ល្បែងគូសតាមស្នាមចុច(ស្រះ (០) និង ដាត់ពណ័រូបភាព



ស្កេន QR Code

សាលាមត្តេយ្យ ..... ថ្នាក់កម្រិត .....

ឈ្មោះ: ..... កាលបរិច្ឆេទ .....

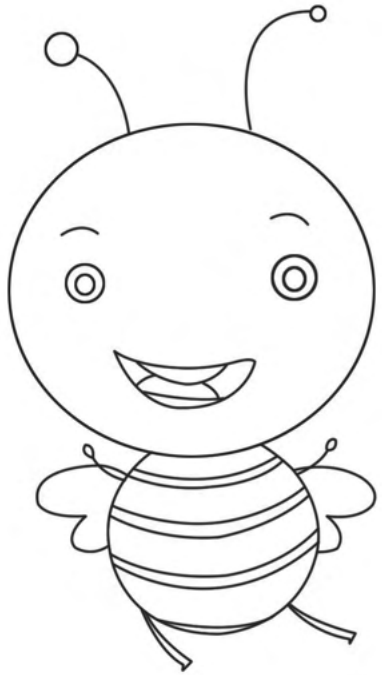
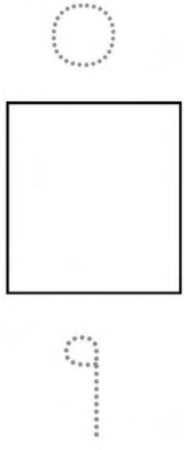
យុំ













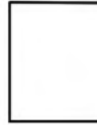

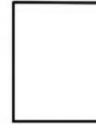



# ល្បែងគូសតាមស្នាមចុច(ស្រះ (០) និង ដាត់ពណ័រូបភាព

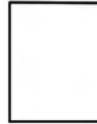

ស្កេន QR Code

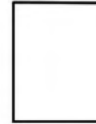
សាលាមត្តេយ្យ ..... ថ្នាក់កម្រិត .....

ឈ្មោះ: ..... កាលបរិច្ឆេទ .....



០៧០

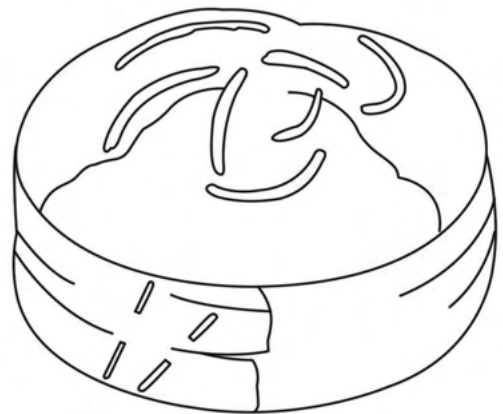

ល្បែងគូសតាមស្នាមចុច(ស្រ: (□) និង ដាត់ពណ័រូបភាព



ស្កែន QR Code

សាលាមត្តេយ្យ ..... ថ្នាក់កម្រិត .....

ឈ្មោះ: ..... កាលបរិច្ឆេទ .....

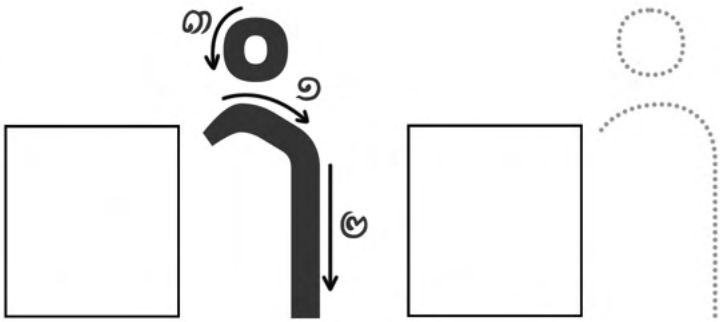
ដំ



ល្បែងគូសតាមស្នាមចុច(ស្រះ (□៖) និង ផាត់ពណ៌រូបភាព



ស្កេន QR Code

សាលាមត្តេយ្យ ..... ថ្នាក់កម្រិត .....

ឈ្មោះ: ..... កាលបរិច្ឆេទ .....

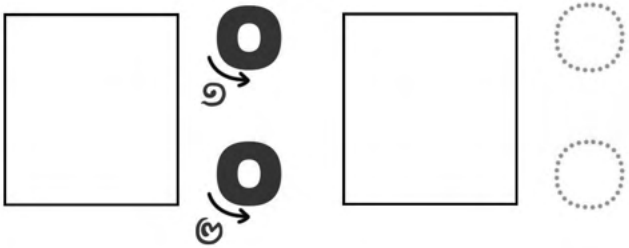
ខ៖ក៏



# ល្បែងគូសតាមស្នាមចុច(ស្រី៖ (្ក្ន) និង ផាត់ពណ៌រូបភាព



ស្កេន QR Code

សាលាមត្តេយ្យ ..... ថ្នាក់កម្រិត .....

ឈ្មោះ ..... កាលបរិច្ឆេទ .....

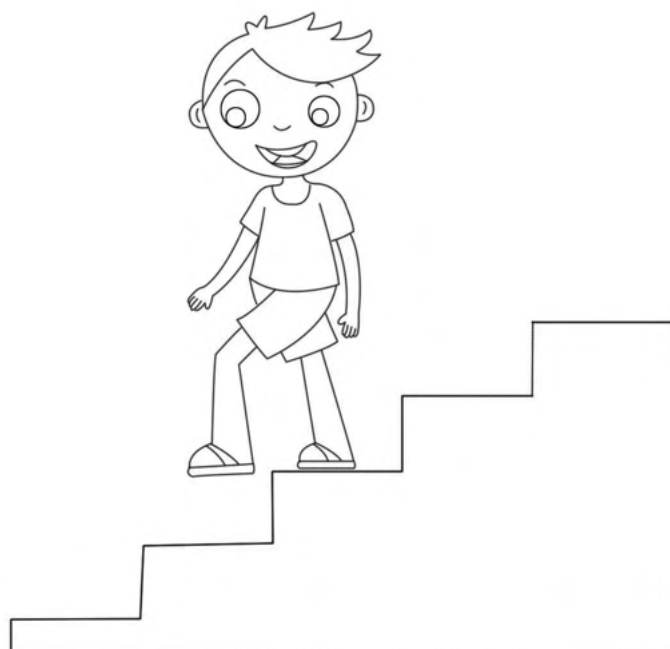
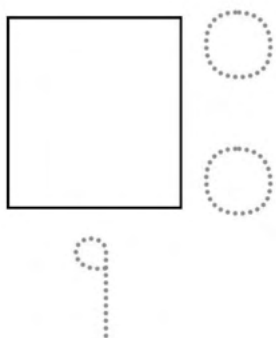
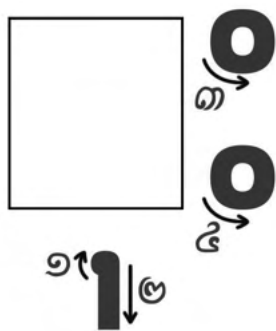
១៖

ល្បែងគូសតាមស្នាមចុច(ស្រ: (៤០៖) និង  
 ផាត់ពណ៌រូបភាព



ស្កេន QR Code

សាលាមត្តេយ្យ ..... ថ្នាក់កម្រិត .....

ឈ្មោះ: ..... កាលបរិច្ឆេទ .....

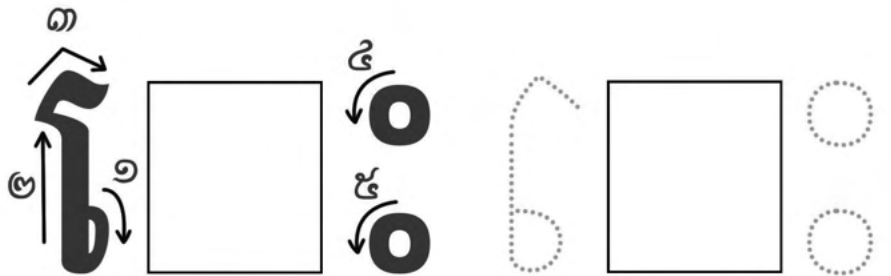
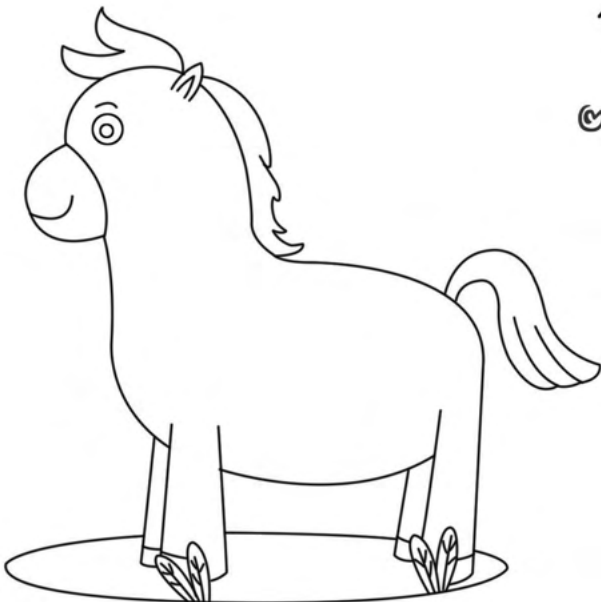
ស្រ:

ល្បែងគូសតាមស្នាមចុច(ស្រះ (្កោះ) និង ផាត់ពណ៌រូបភាព



ស្ត្រីន QR Code

សាលាមត្តេយ្យ ..... ផ្នែកកម្រិត .....

ឈ្មោះ ..... កាលបរិច្ឆេទ .....

ហោះ :

