

កែ

៤

០

២

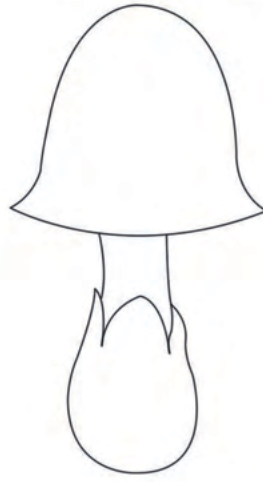

ដូត

២

០

២



ស្រូវ

២

២

២



ស្រូវ

២

០

២



ស្រូវ

២

២

០

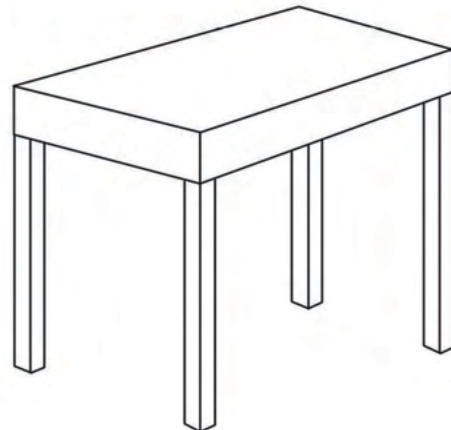

តុ

២

០

១



ធូលី

អង្គការភ្នំមីកកាត់បី ស(ប្រាប់កុមារ R4C)



២



។

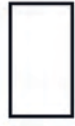

៧



ជួង

អង្គការភ្នំមីកកាត់បី ស(ប្រាប់កុមារ R4C)



។



៧

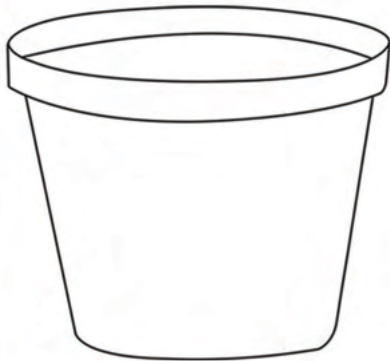

ដើង

អង្គការភ្នំមីកកាត់បី ស(ប្រាប់កុមារ R4C)

ស្រែ

ស្រែ

ស្រែ



ត្បើ

អង្គការភ្នំមីកកាត់បី ស(ប្រាប់កុមារ R4C)

ស្រែ

ស្រែ

ស្រែ

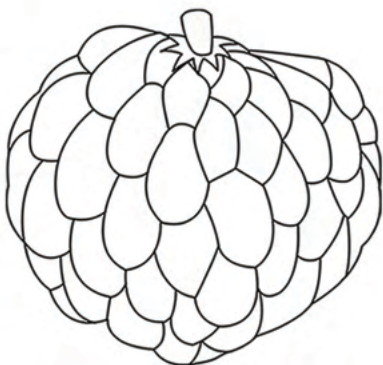

ទៀប

អង្គការភ្នំមីកកាត់បី ស(ប្រាប់កុមារ R4C)

ស្រែ



២

ស្រែ



ចេក

អង្គការភ្នំមីកកាត់បី ស(ប្រាប់កុមារ R4C)

ស្រែ

ស្រែ

ស្រែ

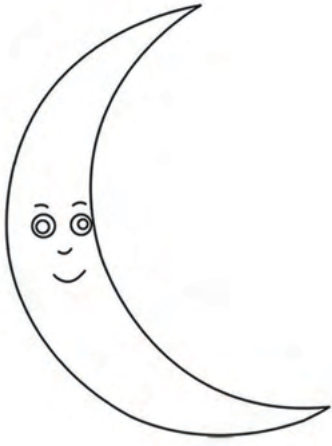

ខែ

ខែ

ខែ

ខែ

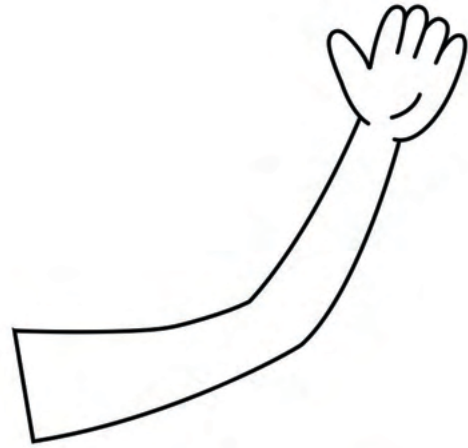

ដៃ

ដៃ

ដៃ

ដៃ

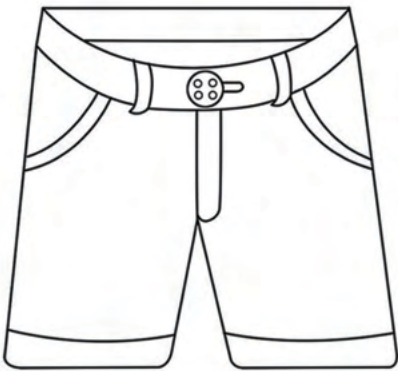

ខោ

ខោ

ខោ

ខោ

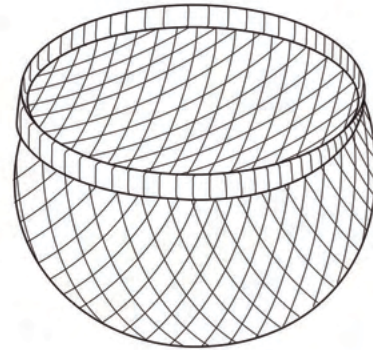

តោ

តោ

តោ

តោ



យ៉ូ

យ៉ូ

យ៉ូ

យ៉ូ



ខ្នុរ

ខ្នុរ

ខ្នុរ

ខ្នុរ



ដាំ

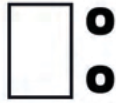

ខ៖កី

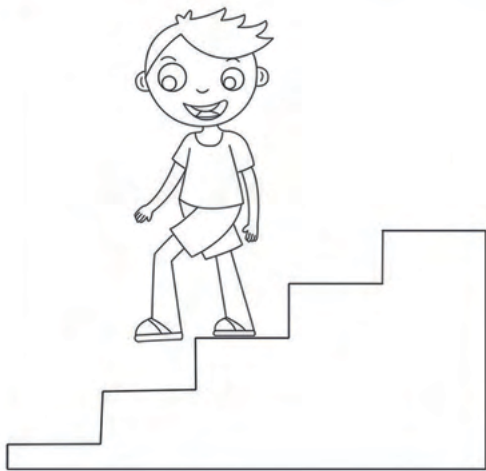
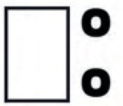

ថ្មុះ

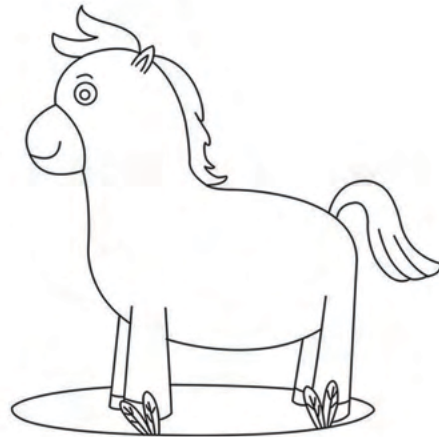

សេះ

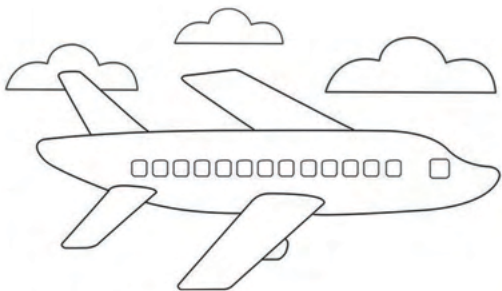
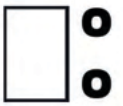

ហោះ

